

Dräger Pac 6x00 / 8x00

Technical manual



Contents

1	Safety-related information	4
1.1	Basic safety information	4
1.2	Safety information on explosion protection	4
2	Conventions used in this document	4
2.1	Definition of alert icons	4
2.2	Typographical conventions	4
2.3	Glossary	4
3	Description	4
3.1	Product overview	4
3.1.1	Gas detector	4
3.1.2	Display	4
3.2	Intended use	4
3.3	Approvals	5
4	Use	5
4.1	Preparations for use	5
4.1.1	Initial start-up	5
4.1.2	Switching on the gas detector	5
4.1.3	Switching off the gas detector	5
4.2	Before entering the workplace	5
4.2.1	Activating the quick menu	5
4.2.2	Opening the quick menu	5
4.2.3	Carrying out a manual bump test	5
4.2.4	Information display	6
4.2.5	Error and warning code displays	6
4.3	During operation	6
4.4	Connecting the gas detector with a smartphone	6
5	Calibrating the gas detector	7
5.1	Opening the maintenance menu	7
5.2	Carrying out a manual fresh air calibration	7
5.3	Carrying out a manual span calibration	8
5.4	Carrying out manual calibration with the Dräger CC-Vision Basic	8
5.5	Carrying out an automatic calibration with the Dräger X-dock	8
6	Troubleshooting	8
7	Maintenance	11
7.1	Configuring the gas detector	11
7.2	Operating time alarm / end of the operating time	11
7.3	Data logger	11
7.4	Replacing the sensor	12
7.5	Battery	12
7.6	Replacing the battery	12
7.7	Replacing the dust and water filter	13
8	Device settings	13
8.1	Factory setting	13
8.2	Alarm settings	14
9	Disposal	14
10	Technical data	14
10.1	Gas detector	14
10.2	Technical data of the sensors and the measuring device settings for Pac 6000/6500	15
10.3	Technical data of the sensors and the measuring device settings for Pac 8000	16
10.3.1	Sensors for Pac 8500 DUAL	18
10.3.2	Cross-sensitivities	19

1 Safety-related information

1.1 Basic safety information

- Before using this product, carefully read the associated instructions for use. This document does not replace the instructions for use.

Incorrect calibration

An incorrect calibration leads to incorrect measured values.

- ▶ The sensitivity must be checked daily before first using the device, with a known concentration of the gas to be measured that corresponds to 25 to 50 % of the final concentration. The accuracy must amount to 0 to +20 % of the actual value. The accuracy can be corrected by calibration.

1.2 Safety information on explosion protection

Devices or components that are used in potentially explosive atmospheres and which are tested and approved in accordance with national, European or international explosion protection guidelines may only be used under the approved conditions in compliance with the statutory provisions.

Oxygen-enriched atmospheres

Explosion protection is not guaranteed in oxygen-enriched atmospheres (>21 Vol% O₂).

- ▶ Remove the device from the potentially explosive atmosphere.

Risk of explosion!

- ▶ Do not open the gas detector in explosion-hazard areas.

Specific application conditions

- In certain extreme conditions, open plastic parts and non-earthed metal parts of the housing may store a combustible level of electrostatic charge.
- Activities such as carrying the device in a bag or attached to a belt, operating the button field or cleaning the device with a damp cloth do not represent a significant electrostatic danger. However, if a mechanism which generates static charge, such as repeated rubbing against clothing, is identified, suitable precautionary measures must be implemented, e.g. the use of anti-static clothing and anti-static footwear.

2 Conventions used in this document

2.1 Definition of alert icons

The following alert messages are used in this document to provide and highlight areas of the associated text that require a greater awareness by the user. A definition of the meaning of each alert message is as follows:

WARNING

Indicates a potentially hazardous situation. If not avoided, it could result in death or serious injury.

NOTICE

Indicates a potentially hazardous situation. If not avoided, it could result in damage to the product or environment.

2.2 Typographical conventions

-  This symbol identifies information that make the product easier to use.

2.3 Glossary

Technical term	Explanation
Operation signal	A periodic optical (green LED) and/or acoustic signal.
D-Light	The D-Light allows the user to check and indicate compliance with certain settings (e.g. bump test interval). The green LED flashes for a short period and superimposes the optical operation signal.

3 Description

3.1 Product overview

3.1.1 Gas detector

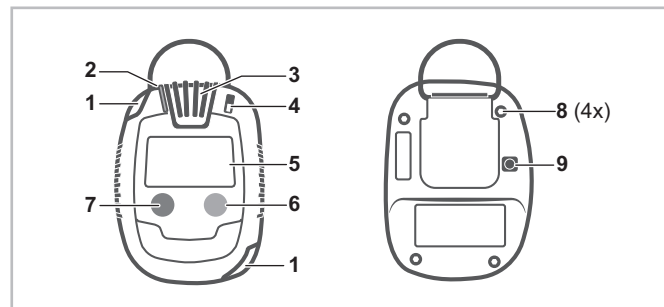

00333742.eps

1 Alarm LEDs	6 [OK] button
2 Operation signal/ D-Light	7 [▼] button
3 Gas inlet	8 Screw (4x)
4 Horn	9 IR interface
5 Display	

3.1.2 Display

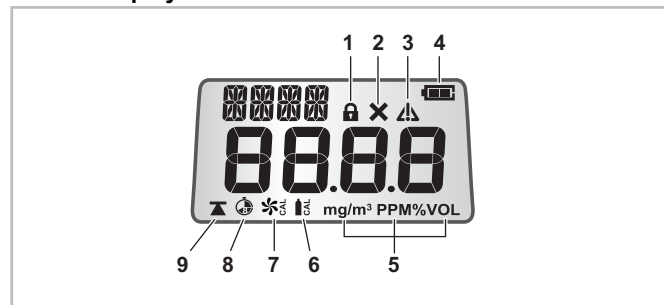

00733742.eps

1 Key word symbol	6 Span calibration
2 Error symbol	7 Fresh air adjustment
3 Information symbol	8 TWA/STEL
4 Battery charge status	9 Peak concentration
5 Measurement unit	

3.2 Intended use

The Dräger Pac 6x00/8x00 is a gas detector and is used to measure and alert the user of gas concentrations in the ambient air.

3.3 Approvals

A copy of the name plate and the declaration of conformity are provided in the enclosed supplementary documentation (order no. 90 33 741).

The name plate on the gas detector must not be concealed.

4 Use

4.1 Preparations for use

4.1.1 Initial start-up

The gas detector remains in deep sleep mode upon delivery and must be activated during the initial start-up.

1. Hold down the [▼] button for approx. 3 s.
This activates the gas detector.

4.1.2 Switching on the gas detector

1. Hold down the [OK] button for approx. 3 s.

The following is displayed or activated:

- Display elements, LEDs, alarm signal and vibration alarm
- Self-test
- Software version and gas name
- Alarm thresholds A1 and A2
- Time to next calibration (configurable)
- Time to expiration of the bump test interval (configurable)

 Before every use, check whether the display elements and information are displayed correctly.

A warm-up phase takes place when first switching on the gas detector (duration depends on the sensor type; see the sensor data sheet).

4.1.3 Switching off the gas detector

- Hold down both keys for approx. 3 s, until shut-down is complete.

4.2 Before entering the workplace

WARNING

Serious damage to health!

An incorrect calibration can lead to incorrect measurement results, which may result in serious damage to health.

- ▶ Before performing safety measurements, check the calibration by way of a bump test, adjust as necessary, and check all alarm elements. If national regulations exist, the bump test must be performed in accordance with these regulations.

WARNING

Incorrect measurement results!

The gas inlet opening is fitted with a filter that protects against dust and water. Contamination may change the qualities of the dust and water filter.

- ▶ Do not damage the filter. Immediately replace damaged or blocked filters.

To ensure correct function:

- Do not cover the gas inlet opening.
- Place the gas detector on clothing near the mouth.
- At temperatures below -20 °C, there may be deviations of >10 % of the measured value if the corresponding sensor was calibrated at room temperature. Dräger recommends

calibration at the primary application temperature if measurements will be taken at very low temperatures. This enables the highest possible measurement accuracy.

After the gas detector has been switched on, the current measured value is shown in the display.

Check whether the warning [!] appears. If it is displayed, we recommend performing a bump test, see Section 4.2.3 on Page 5.

4.2.1 Activating the quick menu

The quick menu can be activated using the Dräger CC-Vision Basic PC software.

Up to two preferred functions can be saved in the quick menu. The following functions are available:

- Fresh air adjustment
- Bump test

4.2.2 Opening the quick menu

Prerequisite:

- The quick menu is activated.

To open the quick menu:

1. Press the [▼] button three times within three seconds.
A double signal tone sounds.
2. Depending on the configuration, the fresh air calibration symbol or the bump test signal will flash.
3. Press the [OK] button to start the feature or press the [▼] button to switch to the next feature or to return to measuring mode (depending on the configuration).

 The quick menu closes automatically after 60 s of inactivity.

4.2.3 Carrying out a manual bump test

WARNING

Danger to health! Do not inhale the test gas.

- ▶ Pay attention to the hazard information in the respective safety data sheets.

Two modes can be selected for a bump test. Use the Dräger CC-Vision Basic PC software to set the mode.

- Quick bump test (test for alarm triggering)
 - Checks whether the pre-alarm threshold (A1) is exceeded (or not reached in the case of O₂).
 - Checks whether the concentration remains above the alarm for a specified period of time.
 - Checks whether the test duration remains below a specified maximum time period.
- Advanced bump test (test for accuracy)
 - Checks whether the defined test gas concentration is reached within a specified tolerance. The tolerance is defined with a default value for each gas in the gas detector, but can be adjusted by the user as needed.
 - Checks whether the test gas concentration remains within the tolerance window for a specified time period.
 - Checks whether the test duration remains below a specified maximum time period.

The bump test can be performed as follows:

- Manual bump test (with quick menu)
- Bump test with X-dock (see instructions for use for the Dräger X-dock)
- Bump test with the Dräger Bump Test Station (see the quick reference guide on the Dräger Bump Test Station)

Prerequisites for the manual bump test:

- The gas detector is switched on.
- A suitable test gas cylinder is available, e.g. a test gas cylinder (order no. 68 11 130) with the following mixed gas ratios: 50 ppm CO, 15 ppm H₂S, 2.5 Vol% CH₄, 18 Vol% O₂

To perform a manual bump test:

1. Prepare a Dräger test gas cylinder. The volume flow must be 0.5 L/min and the gas concentration must be higher than the alarm threshold concentration that is to be tested.
2. Connect the gas detector and the test gas cylinder to the calibration adapter.
3. Press the [▼] button three times within three seconds to open bump test mode (if configured). A signal tone sounds. The notice symbol starts flashing.
4. Press the [OK] button to start the bump test.
5. Open the test gas cylinder valve to let test gas flow over the sensor.
6. If the gas concentration exceeds the alarm threshold A1 or A2, the corresponding alarm triggers.
 - Bump test failed: The gas detector switches to error mode and displays an error. The error symbol flashes, and an error code is displayed until the error is confirmed. Subsequently, instead of the measured value, the - - - display and the error symbol appear. In this case, repeat the bump test or calibrate the gas detector.
 - Bump test passed: **OK** is displayed until the concentration is below A1.

The result of the bump test (passed or failed) is saved in the data logger (see Section on Page 11).

4.2.4 Information display

Different information can be displayed when the device is on and off.

 The information display closes automatically after 3 s of inactivity.

When the gas detector is off:

The following information is displayed:

- Gas name, full scale deflection and measurement module.
- Duration of use (Pac 6000 always, Pac 6500 and 8x00 depending on the configuration)
- Device ID

To display the information:

1. Hold down the [▼] button for approx. 1 s while the device is off. The gas name, full scale deflection and measurement module are displayed.
2. Press the [▼] button to display the information consecutively. The information display closes after the device ID.

When the gas detector is on:

The following information can be displayed depending on the configuration:

- Error codes
- Peak concentration
- Time-weighted average (TWA¹⁾, not for Pac 6000)
- Short-term exposure limit (STEL¹⁾, not for Pac 6000)
- Duration of use (Pac 6000 always, Pac 6500 and 8x00 depending on the configuration)
- Device ID

1) configurable

To display the information:

1. Press the [OK] button in measuring mode. This displays the peak concentration and the symbol for peak concentration.
2. Press the [OK] button to display the information consecutively. The information display closes after the device ID.

4.2.5 Error and warning code displays

If a warning, an error or a notice is pending, the error or notice symbol flashes and a three-digit error code appears.

To display the error and warning codes:

1. Press the [OK] button. If there are several pending error or warning codes, the next error or warning code can be displayed by pressing the [OK] button.

4.3 During operation

WARNING

Danger to life and/or risk of explosion!

The following alarms indicate a danger to life and/or explosion hazard:

- A2 alarm
- STEL or TWA alarm
- Device error
- ▶ Immediately leave the hazard area.

The continuous operation of the gas detector is indicated by an optical and/or acoustic operation signal that is emitted in a 60-second cycle (configurable using the Dräger CC-Vision Basic PC software).

The respective measured value is displayed as an alternating display for dual sensors.

If the allowable measuring range is exceeded or a negative zero drift occurs, the following message appears in the display: **rrr** (concentration too high) or **lll** (negative drift).

The measuring channels do not need to be checked after a brief exceeding of the measuring range by the EC measuring channels (up to one hour) (this does not apply when using DrägerSensor XXS CO H2-CP).

In the event of an alarm, the corresponding displays, including the visual, audible and vibration alarms, are activated, see Section 8.2 on Page 14.

- Press the [▼] button to illuminate the display.

 If the gas detector is used for offshore applications, a distance of 5 m to a compass must be complied with.

4.4 Connecting the gas detector with a smartphone

 Only applies to Pac 6500/8000/8500 with Bluetooth® module. Bluetooth® is not part of the technical suitability test and may only be used in countries for which an approval exists. Contact Dräger for questions on availability.

⚠ WARNING

Risk of explosion!

Using an unsuitable smartphone can lead to ignition of combustible or explosive atmospheres.

- ▶ The smartphone must be suitable and approved for use in explosion-hazard areas.

The gas detector can be connected to a suitable smartphone via Bluetooth®.

The Bluetooth® function and the GATT (Generic Attribute Profile) interface (subject to licensing) can be activated via the PC software CC-Vision.

For specific information about the connection via Bluetooth®, see also the instructions for use of the smartphone used.

Prerequisites:

- Bluetooth® is activated on the gas detector and on the smartphone.
1. Turn on the gas detector.
 2. On the smartphone, select the gas detector:
 - a. Short name of the gas detector in the Android/iOS Bluetooth® menu.
 - b. Part number and serial number in the optional Dräger app.

Both the smartphone and the gas detector are showing a 6-digit number.

3. Check if the numeric codes on the two devices match and if they do confirm on both devices. The connection must be established within 30 s, otherwise the numeric code will become invalid.

The devices are connected.

A successful connection is saved and in future, the two devices will be connected automatically (configurable via the PC software CC-Vision).

If the connection is lost, the gas detector automatically attempts to establish a new connection.

5 Calibrating the gas detector

⚠ WARNING

Danger to health!

Do not inhale the test gas. Observe the hazard warnings on the corresponding Safety Data Sheets and the instructions for use of the gas detector! Observe national regulations when defining calibration intervals.

i For Pac 8500, two measuring channels are used for the calibration.

- Calibration must be performed by qualified personnel after a failed bump test or after a defined calibration interval (see EU standard EN 60079-29-2).
- Recommended calibration interval for the O₂, H₂S and CO sensors: 6 months. Calibration intervals for other gases: see the instructions for use of the respective DrägerSensors.

Calibration can be carried out as follows:

- Manual calibration or calibration using the Dräger CC-Vision Basic
- Automatic calibration with the Dräger X-dock (see the instructions for use for the Dräger X-dock)
- Automatic calibration with the Dräger Bump Test Station (see the quick reference guide on the Dräger Bump Test Station)

5.1 Opening the maintenance menu

i The gas detector automatically returns to measuring mode if no button is pressed in the menu for 1 minute (with the exception of the span calibration menus, where the menu remains active for 10 minutes without any activity).

The maintenance menu is password protected.

Factory setting: 001

1. Hold down the [▼] button for 5 seconds.
2. Enter the password. Press the [▼] button to change the value of the flashing position. Press the [OK] button to confirm the value. Repeat this procedure to define the next two values. After the last confirmation with the [OK] button, the entire password flashes.
3. Press the [OK] button to confirm the password or the [▼] button to cancel the password.
4. If the correct password is entered, a signal tone sounds and the fresh air calibration symbol flashes (configurable).
5. Press the [OK] button to open the fresh air calibration or the [▼] button to switch to the span calibration.
6. Press the [OK] button to open the span calibration or the [▼] button to switch back to measuring mode.

5.2 Carrying out a manual fresh air calibration

To improve accuracy, a fresh air calibration can be carried out if there is a zero deviation.

Observe the following notices for the calibration:

- During fresh air calibrations, the zero point of all sensors (except the DrägerSensors XXS O₂) is set to 0. For the XXS O₂, the reading is set to 20.9 Vol%.
- The DrägerSensor XXS O₃ must be calibrated with a suitable zero gas which is free from carbon dioxide / ozone (e.g. N₂).

To carry out the fresh air calibration:

1. Open the maintenance menu, see Section 5.1 on Page 7.
 2. Press the [OK] button while the fresh air calibration symbol is flashing. The measured value flashes.
 3. Press the [OK] button to confirm the fresh air calibration or the [▼] button to cancel the fresh air calibration. The gas detector returns to measuring mode, or the span calibration symbol flashes (depending on the configuration).
- Fresh air calibration passed: A short double tone sounds, and **OK / gas name** is shown in an alternating display. Press the [OK] button to return to measuring mode.
 - Fresh air calibration failed: A long single tone sounds. --- is displayed instead of the measured value. The error symbol and the fresh air calibration symbol are displayed. In this case, repeat the fresh air calibration or calibrate the gas detector.

5.3 Carrying out a manual span calibration

- Prepare the test gas cylinder, connect the test gas cylinder to the calibration adapter and connect the calibration adapter to the gas detector.
1. Open the maintenance menu, see Section 5.1 on Page 7.
 2. Press the [OK] button while the span calibration symbol is flashing. The configured test gas concentration is displayed. The test gas concentration can be used or adjusted according to the concentration in the test gas cylinder.
 3. Press the [▼] button to change the configured test gas concentration. The first position flashed. Press the [▼] button to change the value of the flashing position. Press the [OK] button to confirm the value. Repeat this procedure to define the next three values. After the last confirmation with the [OK] button, the test gas concentration is complete.
 4. Open the test gas cylinder valve to let test gas flow over the sensor (flow: 0.5 L/min).
 5. Wait until the displayed measured value is stable (after at least 120 seconds).
 6. Press the [OK] button to start the span calibration. The concentration display flashes.
 7. As soon as the measured value displays a stable concentration, press the [OK] button to confirm the span calibration or the [▼] button to cancel the span calibration.

- Span calibration passed: A short double tone sounds, and **OK / gas name** is shown in an alternating display. Press the [OK] button to return to measuring mode.
- Span calibration failed: A tone sounds. --- is displayed instead of the measured value. The error symbol and the span calibration symbol are displayed. In this case, repeat the span calibration.

 To test the measured value configuration times, allow t90 test gas to flow over the calibration adapter on the gas detector. Check the results in accordance with the information in the table (see the supplementary documentation, order no. 90 33 741) up to a reading of 90 % of the final display.

 For Pac 8500, the span calibration is carried out consecutively for the various gasses.

5.4 Carrying out manual calibration with the Dräger CC-Vision Basic

To calibrate the gas detector using the Dräger CC-Vision Basic PC software:

1. Connect the gas detector to a PC using the communication module.
2. The calibration can be carried out using the Dräger CC-Vision Basic PC software. For further information, see the Dräger CC-Vision Basic online help.

 A calibration interval can be set using the "Configurable operating time" (in days) feature, see Section on Page 11.

5.5 Carrying out an automatic calibration with the Dräger X-dock

The gas detector can be automatically calibrated using the Dräger X-dock, see the Dräger X-dock instructions for use.

6 Troubleshooting

An error message is displayed in the event of instrument faults. The number that appears below the message is used for service functions. If the fault remains after turning the device on and off several times, contact the service of Dräger.

Error code	Cause	Remedy
101	Life span of the gas detector expired.	Use a new Pac gas detector.
102	The user's service life counter has elapsed.	Reset the service life counter with the Dräger CC-Vision Basic PC software.
103	Gas detector faulty.	Contact the service of Dräger.
104	Program code checksum error.	Contact the service of Dräger.
105	Bump test interval expired.	Carry out bump test, see Section 4.2.3 on Page 5.
106	Calibration interval expired.	Carry out a span calibration.
107	Software error	Contact the service of Dräger.
109	General error. For example, menu functions cannot be carried out.	Check the configuration, view the error code (e.g. on the information display or with the Dräger CC-Vision Basic PC software)

Error code	Cause	Remedy
111	Alarm element test failed: Alarm lamp.	Repeat the alarm element test with X-dock.
112	Alarm element test failed: Alarm horn.	Repeat the alarm element test with X-dock.
113	Alarm element test failed: Vibration motor.	Repeat the alarm element test with X-dock.
114	Parameter check failed.	Correct the parameters and repeat the test with X-dock.
115	Gas detector deactivated by X-dock.	Activate the gas detector with X-dock.
116	Wrong software version.	Update the software.
117	User parameters implausible.	Check and adjust the configuration of the user parameters.
131	Gas detector faulty.	Contact the service of Dräger.
132	Parameter checksum error.	Carry out a sensor inauguration using the Dräger CC-Vision Basic PC software.
133	Wrong software version for the options board	Update the software.
134	Hardware error.	Contact the service of Dräger.
201	No valid zero adjustment of DrägerSensor XXS measuring channel 1.	Carry out a fresh air calibration, see Section 5.2 on Page 7.
202	No valid span calibration of DrägerSensor XXS measuring channel 1.	Carry out a span calibration, see Section 5.2 on Page 7.
203	The measured value of DrägerSensor XXS measuring channel 1 is in the negative range.	Carry out a fresh air calibration, see Section 5.2 on Page 7.
204	DrägerSensor XXS measuring channel 1 is faulty or not connected.	Check DrägerSensor XXS measuring channel 1, see Section 7.4 on Page 12.
205	Error during the bump test of DrägerSensor XXS measuring channel 1.	Repeat the bump test and calibrate or replace DrägerSensor XXS measuring channel 1 if necessary, see Section 7.4 on Page 12.
206	Faulty filter test.	Repeat the filter test with X-dock.
207	Faulty rise time test.	Repeat the rise test with X-dock.
208	User parameters of the sensor implausible.	Check and adjust the configuration of the sensor parameters.
212	Calibration interval of DrägerSensor XXS measuring channel 1 expired.	Carry out a calibration, see Section 5 on Page 7.
225	Compensation channel error on DrägerSensor XXS measuring channel 1.	Carry out a calibration, see Section 5 on Page 7.
227	Sensor hardware on the gas detector faulty.	Contact the service of Dräger.
228	Compensation channel calibration error on DrägerSensor XXS measuring channel 1.	Carry out a calibration, see Section 5 on Page 7.
301	No valid zero adjustment of DrägerSensor XXS measuring channel 2.	Carry out a fresh air calibration, see Section 5.2 on Page 7.
302	No valid span calibration of DrägerSensor XXS measuring channel 2.	Carry out a span calibration, see Section 5.2 on Page 7.
303	The measured value of DrägerSensor XXS measuring channel 2 is in the negative range.	Carry out a fresh air calibration, see Section 5.2 on Page 7.
304	DrägerSensor XXS measuring channel 2 is faulty or not connected.	Check DrägerSensor XXS measuring channel 2, see Section 7.4 on Page 12.
305	Error during the bump test of DrägerSensor XXS measuring channel 2.	Repeat the bump test and calibrate or replace DrägerSensor XXS measuring channel 2 if necessary, see Section 7.4 on Page 12.
306	Faulty filter test.	Repeat the filter test with X-dock.
307	Faulty rise time test.	Repeat the rise test with X-dock.

Error code	Cause	Remedy
308	User parameters of the sensor implausible.	Check and adjust the configuration of the sensor parameters.
312	Calibration interval for measuring channel 2 expired.	Carry out a calibration, see Section 5 on Page 7.
325	Compensation channel error on DrägerSensor XXS measuring channel 2.	Carry out a calibration, see Section 5 on Page 7.
327	Gas detector faulty.	Contact the service of Dräger.
328	Compensation channel calibration error on DrägerSensor XXS measuring channel 2.	Carry out a calibration, see Section 5 on Page 7.
Warning code	Cause	Remedy
151	Dräger service life expired.	Use a new Pac gas detector.
152	The user's service life counter will elapse soon.	Reset the service life counter with the Dräger CC-Vision Basic PC software.
153	Data memory 90 % full.	Read the data memory and clear it at the next opportunity.
154	Data memory full.	Read the data memory and clear it.
155	Bump test interval expired.	Carry out bump test, see Section 4.2.3 on Page 5.
159	General warning pending. Menu functions cannot be carried out (e.g. notice indicating a warming up sensor).	View the notice code on the information display and confirm it if necessary.
160	Date and time incorrect, e.g. after battery change.	Set the date and time with the Dräger CC-Vision Basic PC software.
162	Battery capacity not available.	Contact the service of Dräger.
165	Bluetooth module error	Contact the service of Dräger.
251	DrägerSensor XXS measuring channel 1 warming up (warm-up phase 1).	Wait until warm-up time is complete.
252	DrägerSensor XXS measuring channel 1 warming up (warm-up phase 2).	Wait until warm-up time is complete.
253	Measuring channel 1 concentration has drifted into the negative range.	Carry out a fresh air calibration for DrägerSensor XXS measuring channel 1, see Section 5.2 on Page 7.
254	The temperature is too high.	Operate the gas detector within the permissible temperature range.
255	The temperature is too low.	Operate the gas detector within the permissible temperature range.
256	Calibration interval for DrägerSensor XXS measuring channel 1 expired.	Carry out a span calibration for DrägerSensor XXS measuring channel 1, see Section 5.3 on Page 8
275	Compensation channel calibration interval	Carry out a calibration for DrägerSensor XXS measuring channel 1, see Section 5 on Page 7.
276	Calibration necessary because of over-gassing of the compensation channel.	Carry out a calibration for DrägerSensor XXS measuring channel 1, see Section 5 on Page 7.
351	DrägerSensor XXS measuring channel 2 warming up (warm-up phase 1).	Wait until warm-up time is complete.
352	DrägerSensor XXS measuring channel 2 warming up (warm-up phase 2).	Wait until warm-up time is complete.
353	Measuring channel 2 concentration has drifted into the negative range.	Carry out a fresh air calibration for DrägerSensor XXS measuring channel 2, see Section 5.2 on Page 7.
354	The temperature is too high.	Operate the gas detector within the permissible temperature range.

Warning code	Cause	Remedy
355	The temperature is too low.	Operate the gas detector within the permissible temperature range.
356	Calibration interval for DrägerSensor XXS measuring channel 2 expired.	Carry out a span calibration for DrägerSensor XXS measuring channel 2, see Section 5.3 on Page 8

7 Maintenance

The following maintenance instructions must be carefully read, understood and followed to prevent flammable or combustible atmospheres from igniting and to ensure that the intrinsic safety of the gas detector is not impaired.

WARNING

Incorrect measurement!

- ▶ A bump test and/or calibration must be performed each time the gas detector is opened. This includes any battery change as well as each sensor replacement in the gas detector.

NOTICE

Damage to components!

The gas detector contains components at risk of charging.

Before opening the gas detector, make sure that the operator is earthed in order to prevent damage to the gas detector. For example, earthing may be ensured by an ESD workplace (electro static discharge).

NOTICE

Damage to the gas detector!

When replacing the battery or the sensor, make sure that no components are damaged or short-circuited.

- ▶ Do not use sharp objects to remove the battery or the sensor.

CAUTION

Danger to health. The sensor contains corrosive liquids. In case of leaks, avoid contact with eyes and skin. In event of contact, rinse with plenty of water.

 For further information on use of the Dräger sensor, please visit the following link:
www.draeger.com/sensorhandbook

WARNING

Replacing components may impair the intrinsic safety of the gas detector. The following maintenance instructions must be carefully read, understood and followed to prevent flammable or combustible atmospheres from igniting and to ensure that the intrinsic safety of the gas detector is not impaired.

- ▶ When replacing the battery or a sensor, do not damage or short-circuit any components. Do not use any sharp objects to remove the battery or the sensor.

WARNING

Incorrect measurement results!

If a battery or sensor replacement is carried out incorrectly, this may cause incorrect measurements.

- ▶ Carry out a bump test and/or calibration each time the gas detector is opened.

The manufacturer's calibration certificate can be downloaded from <https://www.draeger.com/productioncertificates>.

7.1 Configuring the gas detector

The gas detector can be configured using the Dräger CC-Vision Basic PC software. For further information, see the Dräger CC-Vision Basic online help.

To configure the gas detector using the Dräger CC-Vision Basic PC software:

1. Use the communication module (order no. 83 18 587) to connect the gas detector to a PC or the Dräger X-dock maintenance station.
2. The configuration can be carried out using the Dräger CC-Vision Basic PC software. For further information, see the Dräger CC-Vision Basic online help or the instructions for use of the Dräger X-dock maintenance station.

7.2 Operating time alarm / end of the operating time

An individual operating time can be configured using the Dräger CC-Vision Basic PC software to, for example, set a "calibration date", an "inspection date", a "switch-off date", an "operating time alarm" etc.

If an operating time is configured, a warning period starts before the end of the installed operating time. After the gas detector is turned on, the remaining operating time flashes during this warning period, e.g. "30" / "d" (in days).

This operating time alarm triggers at 10 % of the configured operating time (maximum 30 days before the end of the operating time).

7.3 Data logger

The gas detector is equipped with a data logger. The data logger saves events and the average concentration which are stored for the duration of a period of time which can be variably configured using the Dräger Gas Vision PC software or the Dräger CC-Vision Basic PC software. Depending on the number of changing measured values, the data logger runs for up to four weeks at an interval of one minute (configurable). If the data logger memory is full, the data logger overwrites the oldest data.

7.4 Replacing the sensor

WARNING

Risk of explosion! Do not replace the sensor in explosion-hazard areas. Replacing components may impair the intrinsic safety of the gas detector.

The following maintenance instructions must be carefully read, understood and followed to prevent flammable or combustible atmospheres from igniting and to ensure that the intrinsic safety of the gas detector is not impaired.

- ▶ When replacing the sensor, make sure that no components are damaged or short-circuited. Do not use sharp objects to remove the sensor.

 If the gas detector can no longer be calibrated, the sensor must be replaced!

 Only use the DrägerSensor XXS with the same part number!

1. Connect the gas detector to a PC using the communication module.
2. In the CC-Vision Basic PC software¹⁾, open the "Sensor replacement assistant" feature and follow the instructions.
 - a. Switch off the gas detector.
 - b. Loosen the four screws on the rear part of the housing.
 - c. Open the front part of the housing.
 - d. Remove the battery (optional).
 - e. Remove the sensor.
 - f. Insert the new sensor and make a note of the sensor code printed on the sensor.
 - g. If the battery was removed: Wait for 5 seconds, insert new battery. The battery runtime is reset when the battery is inserted.
 - h. Place the front part of the housing on the gas detector and re-tighten the four screws on the rear part of the housing.
3. Sign in the sensor with the previously recorded sensor code.
4. After the sensor replacement, the sensor requires a warm-up phase (see the sensor data sheet). The displayed concentration flashes until the warm-up phase is complete.
5. After the sensor replacement and the warm-up phase, the gas detector must be calibrated (see Section 5 on Page 7).

 If the sensor code of the new sensor does not match that of the previous sensor, the new sensor must be signed on with the CC-Vision Basic PC software as described. Dräger recommends signing on the sensor with the Dräger CC-Vision Basic PC software, even if the sensor code is identical to the previous one.

7.5 Battery

Explanation of the battery display:

The following capacities can be expected with the battery bars displayed:

4 bars	100 % - 75 %
3 bars	74 % - 50 %

2 bars	49 % - 25 %
1 bar	24 % - 5 %
0 bars	4 % - 0 %

The battery bars are an estimate of the battery level. The battery alarm is evaluated exclusively via a voltage measurement under defined load of the battery cell and reflects the actual end of life of the battery cell. The battery pre-alarm is played back as A1 alarm and automatically acknowledged after 60 s. The battery symbol flashes empty. After a battery pre-alarm, there are still around 2 weeks of runtime available. In the event of a gas alarm, the remaining time may be considerably shorter, but it is still at least 1 h in any case. In the event of a main battery alarm, a 10 s countdown occurs and the gas detector turns off and cannot be turned on again for safety reasons. The battery must be replaced.

Battery behaviour: A battery pre-alarm can be triggered by different events. This can also be a temporary voltage drop of the battery cell due to temperatures, etc. Therefore, the battery pre-alarm may be reset by re-measuring the voltage and the gas detector may continue to operate.

Temperature-related battery runtimes as described in the instructions for use refer to predominant operation in the optimal range of 20 °C. Lower temperatures can lead to shortening of the runtime. At the lower end of the specified temperature range, a reduction in runtime of up to 30 % can be expected.

Due to the optimised depassivation and measurement of the battery voltage, there is an audible single to triple "click" of the gas detector every 12 minutes. This is independent of the device status and takes place in the DeepSleep, OFF and ON status of the gas detector.

SAFE MODE (from FW 9.19):

If the voltage drops below a critical level that could cause the gas detector to reset, the gas detector is switched off in a controlled manner with a 10 s countdown.

The gas detector can only be turned on again after 5 minutes. When trying to turn it on beforehand, "SAFE MODE" appears in the display. If this happens several times, the battery is probably empty and Dräger recommends replacing the battery.

 Also see separate document 9300912: Battery activation

7.6 Replacing the battery

WARNING

Risk of explosion!

- ▶ Only the lithium battery type LBT 01** (order no. 83 26 856) may be used.
- ▶ Do not remove or replace batteries in potentially explosive areas. Do not throw used batteries into fire or try to open them by force. Dispose of batteries in accordance with the national provisions.

The battery is part of the Ex approval.

1) A free version of the Dräger CC-Vision Basic PC software can be downloaded at www.draeger.com/software

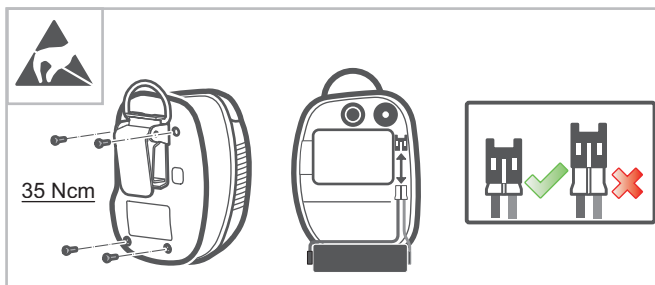

00533742.eps

1. Switch off the gas detector.
2. Loosen the four screws on the rear part of the housing.
3. Open the front part of the housing, remove battery and wait for 5 s.
4. Insert the new battery. Make sure the battery plug is inserted correctly (see figure). The battery runtime is reset when the battery is inserted.
5. Place the front part of the housing on the gas detector and re-tighten the four screws on the rear part of the housing (torque: 35 Ncm).
6. Turn on the gas detector.
A successful battery replacement is confirmed with a vibration (5 s) when the gas detector is turned on. Notice 160 is displayed after the start sequence (see Section 6 on Page 8).
7. Confirm the notice with the [OK] button.
8. After the battery replacement, the sensor requires a warm-up phase (see the sensor data sheet). The displayed concentration flashes until the warm-up phase is complete.

7.7 Replacing the dust and water filter

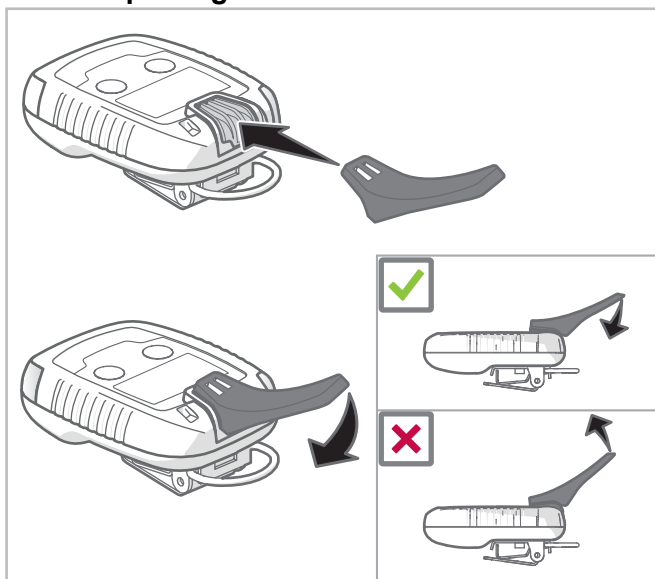

00633742.eps

1. Place the special tool on the dust and water separator.
2. Press the lever on the special tool downward and then remove the dust and water separator.
3. Insert a new dust and water separator. The dust and water separator must click into place.

Sensor grille:	4 units Order no.:	40 units Order no.:
Pac 6xx0	83 26 853	83 26 857
Pac 8xx0	83 26 852	83 26 859

For special gases (ozone, phosgene), the entire front casing, including the special diaphragm, must be replaced due to the special diaphragm.

Front casing:	Order no.:
Pac 8000 ozone	83 26 851
Pac 8000 phosgene	83 26 854

8 Device settings

Only trained and qualified personnel may change the device settings.

8.1 Factory setting

The factory settings may differ for customised orders.

Bump test mode	Quick bump test
Vibration alarm	On
Bump test interval	Off
Operation signal	On
D-Light	On
Switch off	Always
Data logger interval	1 min
Usage duration (user)	Off

8.2 Alarm settings

Alarm	Display	Latching	Acknowledgeable	LED	Horn	Vibration ¹⁾
Alarm 1	A1		✓			✓
Alarm 2	A2	✓				✓
STEL	STEL	✓				✓
TWA	TWA	✓				✓
<input type="checkbox"/> Pre-alarm ²⁾			✓			✓
<input type="checkbox"/> Main alarm ³⁾		✓				✓
Instrument alarm			✓			✓

1) The intensity of the vibration depends on the temperature

2) After the initial battery pre-alarm, the battery's life span amounts to between 1 day and 2 weeks under normal conditions of use. The life span is shorter at low temperatures and/or in the event of alarms.

3) The gas detector automatically switches off after 10 s.

9 Disposal



This product must not be disposed of as household waste. This is indicated by the adjacent symbol. You can return this product to Dräger free of charge. For information please contact the national marketing organizations or Dräger.



Batteries must not be disposed of as household waste. This is indicated by the adjacent symbol. Dispose of batteries at battery collection centers as specified by the applicable regulations.

10 Technical data

10.1 Gas detector

Ambient conditions during operation

Temperature (temperature depending on the sensor)	Up to -30 °C ... +55 °C (briefly up to 1 h -40 °C ... +55 °C)
Humidity	10 ... 90 % r.h., non-condensing
Pressure	700 ... 1300 hPa

Ambient conditions during storage:

Temperature	0 ... 40 °C
Humidity	30 ... 80 % r.h., non-condensing

Typ. battery lifetime (under normal conditions):

24 h operation/day, 1 min alarm/day	Up to 24 months O ₂ sensor: Up to 10 months Dual sensors (without O ₂): Up to 16 months
-------------------------------------	--

Typ. Battery lifetime (under normal conditions, with Bluetooth[®] module):

24 h operation/day, 1 min alarm/day	Up to 14 months O ₂ sensor: Up to 8 months Dual sensors (without O ₂): Up to 11 months
-------------------------------------	---

Typ. Battery lifetime (under normal conditions, with Bluetooth[®] module):

8 h operation/day, 1 min alarm/day	Up to 29 months O ₂ sensor: Up to 10 months Dual sensors (without O ₂): Up to 22 months
Alarm volume	approx. 90 dBA at a distance of 30 cm
Dimensions (not including clip)	64 x 84 x 20 mm
Weight	approx. 106 g (113 g with clip)
Degree of protection	IP 68

10.2 Technical data of the sensors and the measuring device settings for Pac 6000/6500

	CO-LC	H ₂ S-LC	O ₂	SO ₂
Measuring range	0 ... 1999 ppm	0 ... 100 ppm	2 ... 25 Vol%	0 ... 100 ppm
Calibration gas concentration	50 ppm	20 ppm	18 Vol%	10 ppm
Temperature range, operation	-40 ... 50 °C -40 ... 122 °F	-40 ... 50 °C -40 ... 122 °F	-40 ... 50 °C -40 ... 122 °F	-30 ... 50 °C -22 ... 122 °F
Alarm threshold A1 ¹⁾	30 ppm	5 ppm	19 Vol% ²⁾	1 ppm
Acknowledgeable	✓	✓	-	✓
Latching	-	-	✓	-
Alarm threshold A2 ¹⁾	60 ppm	10 ppm	23 Vol%	2 ppm
Acknowledgeable	-	-	-	-
Latching	✓	✓	✓	✓
TWA threshold value ^{1) 3)}	30 ppm	10 ppm	-	1 ppm
STEL threshold value ^{1) 3)}	60 ppm	10 ppm	-	1 ppm
Mean value period	15 min	15 min	-	15 min
Measurement accuracy				
Zero point:	≤ ±2 ppm	≤ ±0.1 ppm	≤ ±0.2 Vol%	≤ ±0.1 ppm
Sensitivity: [% of the measured value]	≤ ±2	≤ ±5	≤ ±1	≤ ±2
Long-term drift (20 °C)				
Zero point:	≤ ±2 ppm/a	≤ ±0.2 ppm/a	≤ ±0.5 Vol%/a	≤ ±1 ppm/a
Sensitivity: [% of measured value/year]	≤ ±3	≤ ±5	≤ ±1	≤ ±2/month
Sensor item number ⁴⁾	68 13 210	68 11 525	68 10 881	68 10 885
Sensor data sheet item number	90 33 454	90 23 970	90 23 820	90 23 919

1) Observe special, customer-requested settings. Device parameters can be changed with the Dräger CC-Vision Basic PC software.

2) For O₂, A1 is the lower alarm threshold for displaying oxygen deficiency.

3) Not applicable for Pac 6000.

4) The sensors have a limited life span. Excessive storage periods compromise the operational life time of the sensors. The adequate temperature range for storage is 0 ... 35 °C (32 ... 95 °F).

10.3 Technical data of the sensors and the measuring device settings for Pac 8000

	NH ₃	PH ₃	HCN	NO	NO ₂ -LC	CO ₂
Measuring range	0 ... 300 ppm	0 ... 20 ppm	0 ... 50 ppm	0 ... 200 ppm	0 ... 50 ppm	0 ... 5 Vol%
Calibration gas concentration	50 ppm in N ₂	0.5 ppm in N ₂	10 ppm in N ₂	50 ppm in N ₂	5 ppm in N ₂	2.5 Vol% in air
Temperature range, operation	-30 ... 50 °C -22 ... 122 °F	-20 ... 50 °C -4 ... 122 °F	-20 ... 50 °C -4 ... 122 °F	-40 ... 50 °C -40 ... 122 °F	-30 ... 50 °C -22 ... 122 °F	-20 ... 40 °C -4 ... 104 °F
Alarm threshold A1 ¹⁾	50 ppm	0.1 ppm	10 ppm	25 ppm	0.5 ppm	0.5 Vol%
Acknowledgeable	✓	✓	✓	✓	✓	✓
Latching	-	-	-	-	-	-
Alarm threshold A2 ¹⁾	100 ppm	0.2 ppm	20 ppm	50 ppm	1 ppm	1 Vol%
Acknowledgeable	-	-	-	-	-	-
Latching	✓	✓	✓	✓	✓	✓
TWA threshold value ¹⁾	20 ppm	0.1 ppm	1.9 ppm	25 ppm	0.5 ppm	0.5 Vol%
STEL threshold value ¹⁾	40 ppm	0.1 ppm	3.8 ppm	50 ppm	1 ppm	2 Vol%
Mean value period	15 min	15 min	15 min	15 min	15 min	15 min
Measurement accuracy						
Zero point:	≤ ±4 ppm	≤ ±0.02 ppm	≤ ±0.5 ppm	≤ ±0.3 ppm	≤ ±0.02 ppm	≤ ±0.3 Vol%
Sensitivity: [% of the measured value]	≤ ±3	≤ ±2	≤ ±5	≤ ±3	≤ ±3	≤ ±20
Long-term drift (20 °C)						
Zero point:	≤ ±5 ppm/a	≤ ±0.05 ppm/a	≤ ±2 ppm/a	≤ ±0.3 ppm/a	≤ ±0.04 ppm/a	≤ ±0.2 Vol%/a
Sensitivity: [% of measured value/month]	≤ ±2	≤ ±2	≤ ±5	≤ ±2	≤ ±2	≤ ±15
Sensor item number ²⁾	68 10 888	68 10 886	68 10 887	68 11 545	68 12 600	68 10 889
Sensor data sheet item number	90 23 922	90 23 920	90 23 921	90 33 091	90 33 093	90 23 923

1) Observe special, customer-requested settings. Device parameters can be changed with the Dräger CC-Vision Basic PC software.

2) The sensors have a limited life span. Excessive storage periods compromise the operational life time of the sensors. The adequate temperature range for storage is 0 ... 35 °C (32 ... 95 °F).

	Cl ₂	OV ¹⁾	OV-A ¹⁾	Ozone	Phosgene	H ₂ HC
Measuring range	0 ... 20 ppm	0 ... 200 ppm	0 ... 200 ppm	0 ... 10 ppm	0 ... 10 ppm	0 ... 4 Vol%
Calibration gas concentration	5 ppm in N ₂	20 ppm in N ₂	20 ppm in N ₂	0.5 ... 9 ppm O ₃	3.8 ... 9 ppm	2 Vol% in air
Temperature range, operation	-30 ... 50 °C -22 ... 122 °F	-20 ... 50 °C -4 ... 122 °F	-20 ... 50 °C -4 ... 122 °F	-20 ... 50 °C -4 ... 122 °F	-20 ... 35 °C -4 ... 99 °F	-20 ... 50 °C -4 ... 122 °F
Alarm threshold A1 ²⁾	0.5 ppm	10 ppm	10 ppm	0.1 ppm	0.1 ppm	20 Vol%
Acknowledgeable	✓	✓	✓	✓	✓	✓
Latching	-	-	-	-	-	-
Alarm threshold A2 ¹⁾	1 ppm	20 ppm	20 ppm	0.2 ppm	0.2 ppm	40 Vol%
Acknowledgeable	-	-	-	-	-	-
Latching	✓	✓	✓	✓	✓	✓
TWA threshold value ¹⁾	0.5 ppm	-	-	0.1 ppm	0.1 ppm	-
STEL threshold value ¹⁾	0.5 ppm	-	-	0.1 ppm	0.1 ppm	-
Mean value period	15 min	-	-	15 min	15 min	-
Measurement accuracy						
Zero point:	≤ ±0.05 ppm	≤ ±3 ppm	≤ ±5 ppm	≤ ±0.02 ppm	≤ ±0.01 ppm	≤ ±0.05 Vol%
Sensitivity: [% of the measured value]	≤ ±2	≤ ±5	≤ ±20	≤ ±3	≤ ±10	≤ ±2
Long-term drift (20 °C)						
Zero point:	≤ ±0.2 ppm/a	≤ ±5 ppm/a	≤ ±5 ppm/a	≤ ±0.02 ppm/a	≤ ±0.2 ppm/a	≤ ±0.05 Vol%/a
Sensitivity: [% of measured value/month]	≤ ±2	≤ ±2	≤ ±3	≤ ±2	≤ ±2	≤ ±3
Sensor item number ³⁾	68 10 890	68 11 530	68 11 535	68 11 540	68 12 005	68 12 025
Sensor data sheet item number	90 23 924	90 23 994	90 23 995	90 33 259	90 23 924	90 33 078

1) Only for ethylene oxide.

2) Observe special, customer-requested settings. Device parameters can be changed with the Dräger CC-Vision Basic PC software.

3) The sensors have a limited life span. Excessive storage periods compromise the operational life time of the sensors. The adequate temperature range for storage is 0 ... 35 °C (32 ... 95 °F).

10.3.1 Sensors for Pac 8500 DUAL

	H ₂ S LC / CO LC	O ₂ / CO-LC	O ₂ / H ₂ S-LC	CO H ₂ -CP
Measuring range	0 ... 100 ppm H ₂ S 0 ... 2000 ppm CO	0 ... 25 Vol% O ₂ 0 ... 2000 ppm CO	0 ... 25 Vol% O ₂ 0 ... 100 ppm H ₂ S	0 ... 2000 ppm
Calibration gas concentration	5 ... 90 ppm H ₂ S 20 ... 450 ppm CO	12 ... 20 Vol% O ₂ 20 ... 1800 ppm CO	12 ... 22 Vol% O ₂ 1 ... 99 ppm H ₂ S	1000 ppm H ₂ 20 ... 1800 ppm CO
Temperature range, operation	-40 ... 50 °C -40 ... 122 °F	-40 ... 50 °C -40 ... 122 °F	-40 ... 50 °C -40 ... 122 °F	-40 ... 50 °C -40 ... 122 °F
Alarm threshold A1 ¹⁾	5 ppm H ₂ S 30 ppm CO	19 O ₂ 30 CO	19 Vol% O ₂ 5 H ₂ S	30 ppm
Acknowledgeable	✓	O ₂ : - CO: ✓	O ₂ : - H ₂ S: ✓	✓
Latching	-	O ₂ : ✓ CO: -	O ₂ : ✓ H ₂ S: -	-
Alarm threshold A2 ¹⁾	10 ppm H ₂ S 60 ppm CO	23 O ₂ 60 CO	23 Vol% O ₂ 10 ppm H ₂ S	60 ppm
Acknowledgeable	-	O ₂ : - CO: -	O ₂ : - H ₂ S: -	-
Latching	✓	O ₂ : ✓ CO: ✓	O ₂ : ✓ H ₂ S: ✓	✓
TWA threshold value ¹⁾	5 ppm H ₂ S 30 ppm CO	30 ppm CO	5 ppm H ₂ S	30 ppm CO
STEL threshold value ¹⁾	10 ppm H ₂ S 60 ppm CO	60 ppm CO	10 ppm H ₂ S	60 ppm CO
Mean value period	15 min	15 min	15 min	15 min
Measurement accuracy				
Zero point:	H ₂ S: ≤ 0.4 ppm CO: ≤ 2 ppm	O ₂ : ≤ ± 0.4 Vol% CO: ≤ ± 2 ppm	O ₂ : ≤ ± 0.4 Vol% H ₂ S: ≤ ± 0.4 ppm	≤ ± 6 ppm
Sensitivity: [% of the measured value]	H ₂ S: ≤ ± 5 CO: ≤ ± 2	O ₂ : ≤ ± 1 CO: ≤ ± 2	O ₂ : ≤ ± 1 H ₂ S: ≤ ± 5	≤ ± 2
Long-term drift (20 °C)				
Zero point:	H ₂ S: ≤ ± 0.2 ppm/a CO: ≤ ± 2 ppm/a	O ₂ : ≤ ± 0.5 Vol%/a CO: ≤ ± 2 ppm/a	O ₂ : ≤ ± 0.5 Vol%/a H ₂ S: ≤ ± 0.2 ppm/a	≤ ± 2 ppm/a
Sensitivity: [% of measured value/year]	H ₂ S: ≤ ± 5 CO: ≤ ± 3	O ₂ : ≤ ± 1 CO: ≤ ± 3	O ₂ : ≤ ± 1 H ₂ S: ≤ ± 5	≤ ± 1/month
Sensor item number ²⁾	68 13 280	68 13 275	68 14 137	68 11 950
Sensor data sheet item number	90 33 511	90 33 510	90 33 842	90 23 924

1) Observe special, customer-requested settings. Device parameters can be changed with the Dräger CC-Vision Basic PC software.

2) The sensors have a limited life span. Excessive storage periods compromise the operational life time of the sensors. The adequate temperature range for storage is 0 ... 35 °C (32 ... 95 °F).

10.3.2 Cross-sensitivities

Cross-sensitivity factors ⁴⁾	CO-LC	H ₂ S	O ₂	H ₂
Acetylene	≤ 2	No effect	≤ -0.5	≤ 0.02
Ammonia	No effect	No effect	No effect	No effect
Carbon dioxide	No effect	No effect	≤ -0.04	No effect
Carbon monoxide	No effect	No effect	≤ 0.2	≤ 0.1
Chlorine	≤ 0.05	≤ -0.2	No effect	No effect
Ethane	No effect	No effect	≤ -0.2	No effect
Ethanol	No effect	No effect	No effect	No effect
Ethylene	No effect	No effect	≤ -1	No effect
Hydrogen	≤ 0.35	No effect	≤ -1.5	No effect
Hydrogen chloride	No effect	No effect	No effect	No effect
Hydrogen cyanide	No effect	No effect	No effect	No effect
Hydrogen sulphide	≤ 0.03		No effect	No effect
Methane	No effect	No effect	No effect	No effect
Nitrogen dioxide	≤ 0.05	≤ -0.25	No effect	No effect
Nitric oxide	≤ 0.2	≤ 0.03	No effect	≤ 0.05
Propane	No effect	No effect	No effect	No effect
Sulphur dioxide	≤ 0.04	≤ 0.1	No effect	No effect

Dräger Safety AG & Co. KGaA

Revalstraße 1
23560 Lübeck, Germany
Tel +49 451 882 0
Fax +49 451 882 20 80
www.draeger.com

90 33 742 - TH 4623.700

© Dräger Safety AG & Co. KGaA
Edition 04 - May 2023 (Edition 01 - July 2017)
Subject to alteration