



Dräger X-am 2500 (MQG 0011) Technical Manual



Content

1	For your safety	4			
1.1	General safety statements	4			
1.2	Definitions of alert icons	4			
2	Description	4			
2.1	Product overview	4			
2.1.1	Front	4			
2.1.2	Rear side	4			
2.1.3	Display	4			
2.1.4	Special symbols	4			
2.2	Intended use	5			
2.3	Approvals	5			
2.3.1	Safety Instructions	5			
3	Operation	6			
3.1	Preparations for operation	6			
3.1.1	Charging the batteries	6			
3.1.2	Replacing the batteries / rechargeable batteries	7			
3.1.3	Switching on the instrument	8			
3.1.4	Switching off the instrument	8			
3.2	Before entering the workplace	8			
3.3	Configuration	9			
3.3.1	Standard gas configuration	9			
3.3.2	Standard instrument configuration	10			
3.3.3	Configuring the device	10			
3.3.4	Export data memory and display graphically	11			
3.4	Running the bump test	11			
3.4.1	Manual implementation without documentation of the results in the instrument memory	11			
3.4.2	Menu implementation with the documentation of results in the instrument memory	12			
3.4.3	Automatic implementation with the Bump Test Station	13			
3.5	During operation	13			
3.6	Identifying alarms	14			
3.6.1	Concentration pre-alarm A1	14			
3.6.2	Concentration main alarm A2	14			
3.6.3	STEL/TWA exposure alarm	14			
3.6.4	Battery pre-alarm	14			
3.6.5	Battery main alarm	14			
3.6.6	Instrument alarm	14			
4	Menu functions	15			
4.1	Activating the Info mode	15			
4.2	Opening Info-Off Mode	15			
4.3	Quick Menu	15			
4.3.1	Quick menu functions	15			
4.3.2	Opening the Quick Menu	15			
4.3.3	Quick menu "Delete peak values"	15			
4.4	Calibration Menu	15			
4.4.1	Calibration menu functions	15			
4.4.2	Open the Calibration Menu	15			
5	Calibrate instrument	16			
5.1	Adjustment interval	16			
5.2	Run fresh air calibration	16			
5.3	Automatic fresh air calibration of the CatEx sensor in the charging cradle	17			
5.4	1-button calibration	17			
5.4.1	Calibrating the sensitivity for an individual measuring channel	18			
5.4.2	Sensitivity calibration for CatEx	18			
5.5	Calibration with the X-dock maintenance station	19			
6	Operation with pump	19			
6.1	Performing a measurement with the Dräger X-am Pump	19			
6.2	Performing a measurement with a manual pump adapter and rubber ball pump	20			
7	Replacing the sensors	20			
8	Troubleshooting	21			
8.1	Warning messages	21			
8.2	Fault message	23			
9	Maintenance	26			
9.1	Maintenance table	26			
10	Cleaning	26			
11	Storage	26			
12	Disposal	26			
13	Technical data	27			
13.1	X-am 2500	27			
14	Order list	28			



1 For your safety

1.1 General safety statements

- Before using this product, carefully read the associated Instructions for Use. This document does not replace the Instructions for Use.

1.2 Definitions of alert icons

The following alert icons are used in this document to provide and highlight areas of the associated text that require a greater awareness by the user. A definition of the meaning of each icon is as follows:



-  **WARNING**
Indicates a potentially hazardous situation which, if not avoided, could result in death or serious injury.
-  **CAUTION**
Indicates a potentially hazardous situation which, if not avoided, could result in physical injury, or damage to the product or environment. It may also be used to alert against unsafe practices.
-  **NOTICE**
Indicates additional information on how to use the product.

2 Description

2.1 Product overview

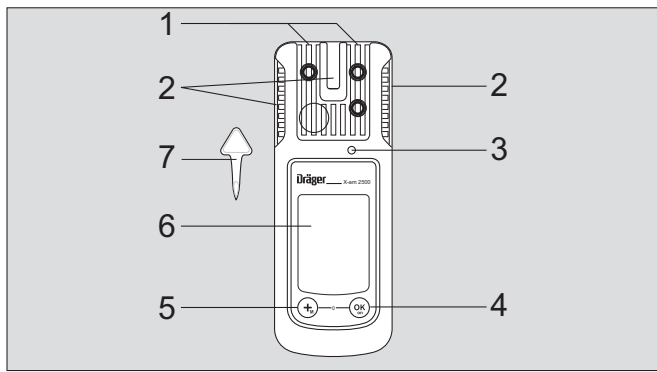
2.1.1 Front



- 1 Gas entry
- 2 Alarm LED
- 3 Horn
- 4  key
- 5  key
- 6 Display
- 7 Tool for changing sensor

2.1.2 Rear side

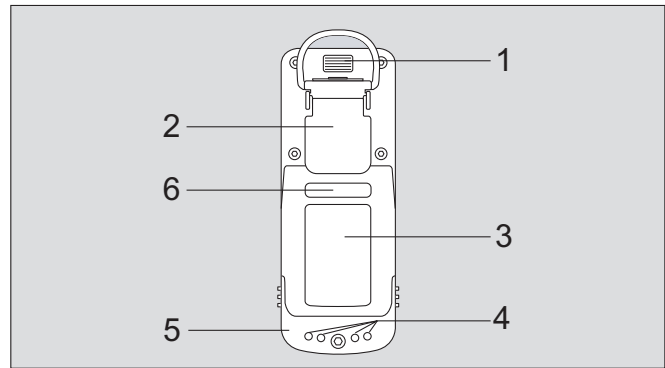

- 1 IR interface
- 2 Fastening clip
- 3 Nameplate
- 4 Charging contacts
- 5 Power pack
- 6 Serial no.



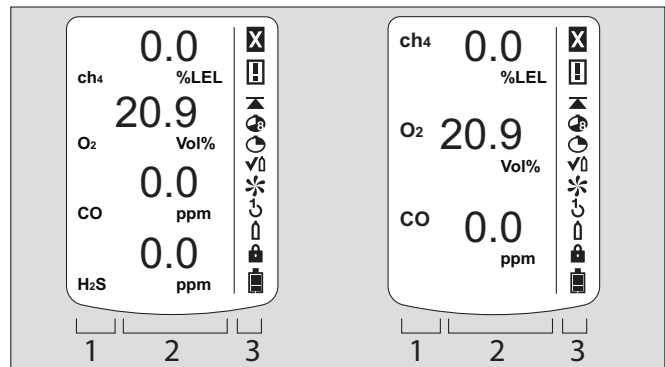

2.1.3 Display



- Left: 4 measuring channels, right: 3 measuring channels
- 1 Measured gas display
 - 2 Measuring value display with unit
 - 3 Special symbols

The following only shows the instrument version with 4 measuring channels.

2.1.4 Special symbols

-  Fault message, see section 4.1 on page 15
-  Warning message, see section 4.1 on page 15
-  Display of peak values for all measured gases, see section 4.1 on page 15
-  The exposure evaluation display (TWA) for measured gases, e.g. H₂S and CO, see section 4.1 on page 15
-  The exposure evaluation display (STEL) for measured gases, e.g. H₂S und CO, see section 4.1 on page 15

- ✓ The instrument is set to the bump test function, see section 3.4 on page 11
- ✱ The instrument is set to the fresh air calibration function, see section 5.2 on page 16
- ↻ The instrument is set to the 1-button calibration/adjustment function, see section 5.4 on page 17
- ↑ The instrument is set to the single gas calibration function, see section 5.4.1 on page 18
- 🔒 Function for password input is active, see section 4.4 on page 15
- 🔋 Battery / rechargeable battery 100 % full
- 🔋 Battery / rechargeable battery 2/3 full
- 🔋 Battery / rechargeable battery 1/3 full
- 🔋 Battery / rechargeable battery empty

2.2 Intended use

Portable gas detection instrument for the continuous monitoring of the concentration of several gases in the ambient air within the working area and in explosion-hazard areas. Independent measurement of up to 4 gases, in accordance with the installed Dräger sensors.

Areas subject to explosion hazards, classified by zones

The instrument is intended for the use in explosion-hazard areas of Zone 0, Zone 1 or Zone 2 or in mines at risk due to fire damp. It is intended for use within a temperature range of -20 °C to +50 °C, and for areas in which gases of explosion groups IIA, IIB or IIC and temperature class T3 or T4 (depending on the batteries and rechargeable battery) may be present. If used in mines, the instrument is only to be used in areas known to have a low risk of mechanical impact.

Areas subject to explosion hazards, classified by divisions.

The instrument is intended for use in explosion-hazard areas according to Class I&II, Div. 1 or Div. 2 within a temperature range of -20 °C to +50 °C, and for areas where gases or dusts of groups A, B, C, D, E, F, G and temperature class T3 or T4 may be present (depending on the rechargeable battery and batteries).



WARNING

CSA requirement: Measured values over the full scale value may indicate an explosive atmosphere.

Only applicable to Class II certification. CSA Std. C22.2 No 152 does not have any requirement for Class II hazardous locations and therefore this device has not been performance tested by CSA for Class II. The sensor may become clogged and not detect gas properly or warn the user of its inability to detect gas.



WARNING

CSA requirement: The sensitivity must be tested on a daily basis before first use with a known concentration of the gas to be measured in accordance with 25 to 50 % of the concentration limit value. The accuracy must be 0 to +20 % of the actual value. The accuracy can be corrected via calibration.



NOTICE

CSA requirement: Only the combustible gas detection portion of this instrument has been assessed for performance. The instrument has not been classified by the CSA for use in mines.

2.3 Approvals

Copies of the name plate and the declaration of conformity are provided in the enclosed supplementary documentation (order no. 90 33 890).

Do not stick anything on the name plate on the gas detector. The technical approvals are valid for the X-am 2500 gas detection instrument and the calibration cradle. The explosion-protection approvals are only valid for the X-am 2500 gas detection instrument; the calibration cradle must not be used in the Ex zone.

The BVS 10 ATEX E 080 X technical suitability test is based on the calibration with the target gas.

2.3.1 Safety Instructions



WARNING

Do not replace or charge batteries in potentially explosive areas. Explosion hazard!

Charge the NiMH power pack T4 (type HBT 0000) or T4 HC (type HBT 0100) with the associated Dräger charger. Charge NiMH single cells for ABT 0100 battery holder in accordance with the manufacturer's specifications. Ambient temperature during the charging process: 0 to +40 °C.

To reduce the danger of explosion, do not mix new batteries with old batteries and do not mix batteries made by different manufacturers.

Always disconnect the instrument from the power pack before carrying out any maintenance operations.

Substitution of components may impair intrinsic safety.

Only use power packs ABT 0100 (order no. 83 22 237), HBT 0000 (order no. 83 18 704) or HBT 0100 (order no. 83 22 244). See marking on power pack for approved batteries and related temperature classes.

Not tested in an oxygen-enriched atmosphere (>21 % O₂).

High off-scale readings may indicate an explosive concentration.

Note the following for CSA (Canadian Standards Association) applications:

For the CSA approval only the functions of the device component that is used to measure flammable gases are tested. The device is not approved by CSA for use in mining.

WARNING

Before daily use, test the sensitivity with a known concentration of the applicable gas corresponding to 25 to 50 % of the maximum concentration. The accuracy must be within a range of 0 to +20 % of the actual value. Perform a calibration to correct the accuracy if necessary.

3 Operation

3.1 Preparations for operation

WARNING

To reduce the risk of ignition of a flammable or explosive atmosphere, strictly adhere to the following warning statements: Only use power pack types ABT 01xx, HBT 00xx or HBT 01xx. See the marking on the rechargeable battery for permitted rechargeable batteries and the corresponding temperature class.

Substitution of components may impair intrinsic safety.

- Before using the instrument for the first time, insert a charged NiMH T4 power pack or batteries approved by Dräger see section 3.1.2 on page 7.
- The instrument is now ready for operation.

3.1.1 Charging the batteries

WARNING

Explosion hazard! To reduce the risk of flammable or explosive atmospheres igniting, it is essential that the warning notices below are observed:
Do not charge underground or in explosion hazard areas!

The chargers are not designed in accordance with the regulations for fire damp and explosion protection.

Charge the NiMH power pack T4 (type HBT 0000) or T4 HC (type HBT 0100) with the associated Dräger charger. Charge NiMH single cells for ABT 0100 battery holder in accordance with the manufacturer's specifications. Ambient temperature during the charging process: 0 to +40 °C.

NOTICE

Even if the instrument is not used, Dräger recommends storing the instrument in the charging cradle (charging module X-am 1/2/5000, order no. 83 18 639).

- To maintain the lifetime of the batteries, charging is temperature controlled and only performed in a temperature range of 5 to 35 °C. When outside this temperature range, the charging automatically interrupted and automatically recommenced after the temperature range has been reached again.

- The charging time is typically 4 hours.
- A new NiMH power pack reaches its full capacity after three complete charging/discharging cycles.
- Never store the instrument for extended periods without being connected to a power source (maximum of 2 months) because the internal buffer battery will drain.

Charging with the charging module adapter and the power supply unit 83 21 849 or 83 21 850

- A maximum of 5 instruments in charging modules (order no. 83 18 639) can be charged at the same time on the charging module adapter (order no. 83 25 736) in connection with the power supply unit (order no. 83 21 849). Up to 20 instruments can be charged at the same time with the power supply unit 83 21 850.
- Before attaching the charging modules to the charging module adapter, disconnect the power supply unit from the mains supply!

CAUTION

Always connect or disconnect the charging modules individually and never in groups in order to prevent the charging module adapter from becoming damaged. Even during transportation, always handle the power supply unit and the charging modules individually and without instruments inserted.

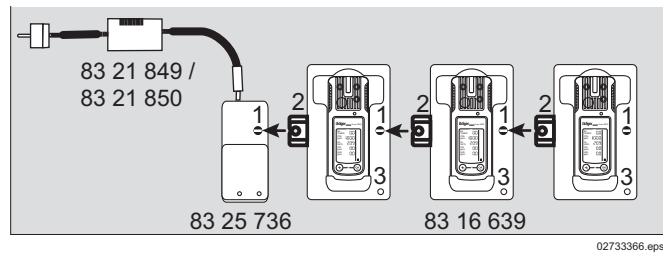

- Position the instrument on an even and level surface.
- 1. Turn the slots of the interlock into a horizontal position by using a screwdriver or coin.
- 2. Insert the fastening lug (2) of the charger module (simultaneous power feed) until it engages.
- 3. Close the lock (1) with a quarter turn (slot is positioned vertically).
- 4. Attach additional charging modules in the same way.
- 5. Connect the power pack to the mains.
 - The green LED (3) lights up.
- 6. Insert the switched off instrument into the charger module.
 - Display LED (3) on the charger module:
 - ▬▬▬▬▬▬ Charging
 - ▬▬▬▬▬▬ Fault
 - ▬▬▬▬▬▬ Full
- If a fault occurs:
 - Remove the instrument from the charging module and insert it again.
- If the fault still occurs, have the charging module repaired.
 - It takes approx. 4 hours to fully charge an empty rechargeable battery.

**CAUTION**

A short circuit of the charging contacts in the charging modules, e. g., by metallic objects that have fallen in, does not result in damage to the charging station. It should, however, be avoided due to possible heating hazards and incorrect displays on the charger module.

**NOTICE**

If combining different charging modules, follow the instructions in the manual supplied with the charging module adapter.

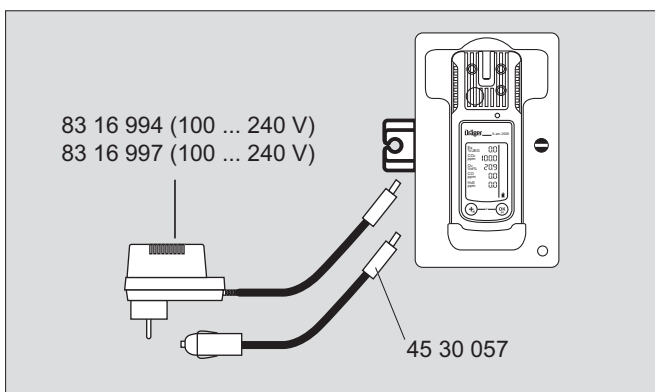
Charge using charger module and plug-in power pack or vehicle charging adapter

02833366.eps

- When using the power supply unit (order no. 83 16 994), up to 5 instruments can be charged at the same time, with the power supply unit (order no. 83 16 997) one instrument individually.
- When using the vehicle charging adapter (order no. 45 30 057) it is recommended that you supply every charging module separately.
- The charging process is carried out analogous to charging with the multiple charging station.

3.1.2 Replacing the batteries / rechargeable batteries**WARNING**

Explosion hazard! To reduce the risk of flammable or explosive atmospheres igniting, it is essential that the warning notices below are observed:

Do not throw used batteries into fire or try to open them by force.

Do not replace or charge batteries in areas at risk of an explosion hazard.

Do not mix new batteries with used batteries, and do not mix batteries from different manufacturers or of different types.

Remove batteries before maintenance work.

Batteries / rechargeable batteries are part of the Ex approval.

Only the following types may be used:

- Alkaline batteries – T3 – (non rechargeable!)
- Panasonic LR6 Powerline
- Varta Type 4106 ¹⁾ (power one) or
- Varta Type 4006 ¹⁾ (industrial)
- Alkaline batteries – T4 – (non rechargeable!)
- Duracell Procell MN1500¹⁾, Duracell Plus Power MN1500¹⁾
- NiMH rechargeable batteries – T3 – (rechargeable)
- GP 180AAHC ¹⁾ (1800 mAh) max. 40 °C ambient temperature.

Charge the NiMH power pack T4 (type HBT 0000) or T4 HC (type HBT 0100) with the associated Dräger charger. Charge NiMH rechargeable batteries for battery holder ABT 0100 in accordance with the manufacturer's specifications. Ambient temperature during the charging process: 0 to +40 °C.

1) Not part of the measurement performance tests BVS10 ATEX E 080X and PFG 10 G 001X.

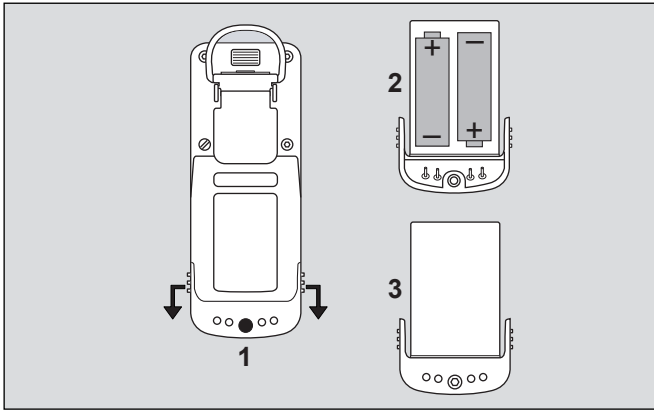

02633366.eps

1. Switching off the instrument: **OK** key and **+** key are held down simultaneously.
2. Loosen the screw (2.0 mm hexagon socket) on the power pack and remove the power pack.
 - With battery holder (order no. 83 22 237): Replace alkaline batteries or NiMH rechargeable batteries. Ensure correct polarity.
 - With the T4 NiMH power pack (type HBT 0000) / T4 HC (type HBT 0100): Completely replace the power pack.
3. Insert the power pack into the instrument and tighten the screw, the instrument switches on automatically.

After replacing the T4 NiMH power pack (type HBT 0000)/ T4 HC (type HBT 0100), a full charge is recommended.

After the batteries have been replaced:

- The settings and data are stored when the battery is replaced. The sensors warm up again.

3.1.3 Switching on the instrument

1. **Hold down the [OK] button** for approx. 3 seconds until the » **3 . 2 . 1** « countdown shown on the display has elapsed.
 - All the display segments, including the visual, audible and vibration alarms, are activated for a short time.
 - The software version is displayed.
 - The instrument performs a self-test.
 - The sensor that is up next for calibration/adjustment is displayed with the remaining days until the next calibration/adjustment e. g. » **Ex %LEL CAL 20** «.
 - The time until the bump test interval elapses is displayed in days, e.g. » **bt 123** «.
 - All A1 and A2 alarm thresholds and » **TWA** ¹⁾ and » **STEL** ¹⁾ for all toxic gases (e. g. H₂S or CO) are displayed consecutively.

During the sensor warm-up phase:

- The display for the measured value flashes
 - The special symbol » **!** « is displayed.
 - No alarms are issued during the warm-up phase.
 - The red LEDs flash.
 - The gas detector is ready to measure when the measured values no longer flash and the red LEDs are no longer illuminated. The special symbol » **!** « may continue to be displayed if corresponding warnings (e.g. not yet ready for calibration) are active.
2. Press the **[OK]** key to cancel the display of the activation sequence.

1) Only when activated in the instrument configuration. Delivery condition: not activated.

3.1.4 Switching off the instrument

- Press and hold the **[OK]** key and **[+]** key simultaneously until the countdown » **3 . 2 . 1** « shown on the display has elapsed.

When the instrument is switched off, the visual, audible and vibration alarms are activated for a short time in order to protect against inadvertent switch off.

3.2 Before entering the workplace



WARNING

Before any measurements relevant to safety are made, check the adjustment with a bump test, adjust if necessary and check all alarm elements. If national regulations apply, a bump test must be performed according to the national regulations. Faulty adjustment may result in incorrect measuring results, with possible serious consequences.



CAUTION

The CatEx sensor is intended for measurements of flammable gases and vapours mixed with air (i.e. O₂ content ≈ 21 vol.%). Incorrect measured values may be displayed in the case of oxygen deficient or oxygen enriched environments.



NOTICE

If the gas detector is used for offshore applications, a distance of 5 m to a compass must be complied with.

1. Switch on the instrument. The current measured values are shown in the display.
2. Observe any warning » **!** « or fault messages » **!** «.
 - ▣ The instrument can be operated normally. If the warning message does not disappear automatically during operation, the instrument must be serviced after the end of use.
 - ▣ The instrument is not ready to measure and requires maintenance.
3. Check that the gas inlet opening on the instrument is not covered.



WARNING

Explosion hazard! To reduce the risk of flammable or explosive atmospheres igniting, it is essential that the warning notices below are observed:

- Fractions of catalytic poisons in the measuring gas (e.g. volatile silicone, sulphur, heavy metal compounds or halogenated hydrocarbon) can damage the CatEx sensor. If the CatEx sensor can no longer be calibrated to the target concentration, the sensor must be replaced.
- In case of measurements in an oxygen-deficient atmosphere (<12 Vol.-% O₂) the CatEx sensor may show incorrect displays; in this case, a reliable measurement with a CatEx sensor is not possible.
- In an oxygen enriched atmosphere (>21 vol. % O₂), the explosion protection cannot be guaranteed; remove instrument from the Ex area.
- High values outside the display area indicate an explosive concentration where applicable.

3.3 Configuration

3.3.1 Standard gas configuration

DrägerSensor	Measuring range ¹⁾	Alarm A1 ¹⁾			Alarm A2 ¹⁾		
		threshold	can be acknowledged	self-latching	threshold	can be acknowledged	self-latching
CatEx 125 PR [%LEL]	0 to 100	20	yes	no	40	no	yes
CatEx 125 PR Gas [%LEL]	0 to 100	20	yes	no	40	no	yes
XXS O ₂ [Vol.-%]	0 to 25	19 ²⁾	no	yes	23	no	yes
XXS CO LC [ppm]	0 to 2000	30	yes	no	60	no	yes
XXS H ₂ S LC [ppm]	0 to 100	5	yes	no	10	no	yes
XXS NO ₂ [ppm]	0 to 50	5	yes	no	10	no	yes
XXS SO ₂ [ppm]	0 to 100	0.5	yes	no	1	no	yes

1) Different settings can be selected to meet customer requirements on delivery. The current setting can be checked and changed with the Dräger CC Vision software.

A version of the CC-Vision software that can be used for Dräger X-am 2500 is available for download from the product page for the X-am 2500 at the following web address: www.draeger.com

2) With O₂, A1 is the lower alarm threshold: an alarm is triggered if the value is too low.

3.3.2 Standard instrument configuration



NOTICE

Only trained persons are permitted to carry out modifications to the instrument configuration.

Dräger X-am [®] 2500 ¹⁾	
Bump test mode ²⁾	Extended bump test
Fresh air calibration ²⁾	ON
Operating signal ^{2) 3)}	ON
Capture range	ON
Switch off ²⁾	allowed
LEL factor ²⁾ (ch ₄)	4.4 (vol. %) (4.4 vol. % corresponds to 100 %LEL)
STEL ^{2) 4) 5)} (short-term average)	STEL function - disabled Average value duration = 15 minutes
TWA ^{2) 5) 6)} (shift average)	TWA function - disabled Average value duration = 8 hours
Alarm A1 ⁷⁾	can be acknowledged, non-latching, pre-alarm, rising flank
Alarm A1 at O ₂ sensor	cannot be acknowledged, latching, like main alarm, falling flank
Alarm A2 ⁷⁾	cannot be acknowledged, latching, main alarm, rising flank

- 1) X-am[®] is a registered trademark of Dräger.
- 2) Different settings can be selected to meet customer requirements on delivery. The current setting can be checked and changed with the Dräger CC Vision software.
- 3) A periodic short flashing indicates the operating capacity of the instrument. If there is no operating signal, correct operation cannot be guaranteed.
- 4) STEL: average value of an exposure over a short period, generally 15 minutes.
- 5) Interpretation only if the sensor is designed for this.
- 6) TWA: shift averages are workplace limit values for generally eight hours per day of exposure for five days a week during a working life.
- 7) Latching and acknowledgement of alarms A1 and A2 can be configured with the Dräger CC Vision PC software.

Changing the configuration: see “Replacing the sensors” on page 20.



WARNING

After a basic initialization has been carried out with the PC software Dräger CC Vision, individual alarm settings may have been changed.

Selecting or disabling the capture ranges (only applies for the measuring mode):

The capture range is selected in the measuring mode (factory setting) and permanently disabled in calibration mode. The CC-Vision PC software can be used to select or disable the capture ranges for the measuring mode.

3.3.3 Configuring the device

To individually configure a instrument with standard configuration, the instrument must be connected with a PC. The installed PC software Dräger CC Vision is used for configuration. The PC software Dräger CC Vision can be downloaded from the following web address free of charge: www.draeger.com/software.

- Observe the documentation and online help for the software.

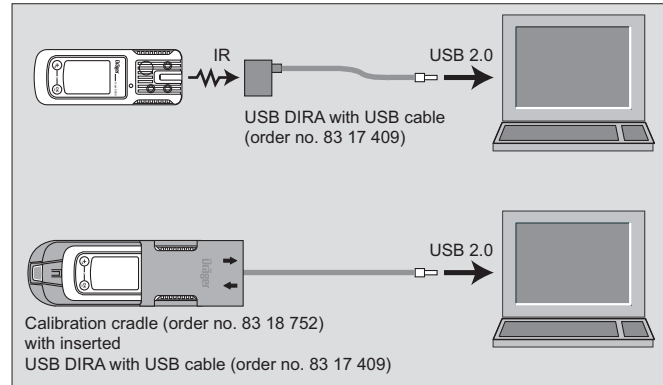

Device settings

The following changes can be made to the device parameters for a device:

Designation	Field
Password	Numeric field (3-figure)
Operating signal LED ¹⁾	Yes/No
Operating signal horn ¹⁾	Yes/No
Switch-off mode	“Switch off permitted” or “Switch off prohibited” or “Switch off prohibited at A2”
Shift length (TWA) ²⁾ (in minutes)	60 - 1440 (setting for exposure alarm)
Short-term exposure limit (STEL) ^{3) 4)} (in minutes)	0 - 15 (setting for exposure alarm)
User ID(12 characters)	Alphanumeric field
Switch database on or off	On/Off
Overwrite database	Yes/No
Database mode	Peak/Average
Database interval	1 s / 10 s / 30 s / 1 min / 2 min / 5 min / 10 min / 30 min
Date	(date on the PC)
Time	(time on the PC)
Warning after expiry of calibration interval	Yes/No
Error after expiry of calibration interval	Yes/No
Delay until error after expiry of calibration interval (days)	0 - 10
Automatic detection of Bump Test Station	Yes/No
Activate sensitivity calibration following negative bump test	Yes/No (relates only to a device connected to the Dräger Bump Test Station)
Bump test mode	“extended bump test” or “quick bump test” or “bump test deactivated”
Warning after expiry of bump test interval	Yes/No

Designation	Field
Error after expiry of bump test interval (if warning activated)	Yes/No
Capture range	Yes / No
Remote configuration	Yes / No
Bump test interval (days)	1 - 732
Delay until error after expiry of cal. interval (days)	0 - 10
Activate user service life	Yes/No
User service life (days) (if activated)	0 - 999
Running in	Yes/No
LEL category	"---" or "PTB" or "IEC" or "NIOSH" (if this is changed, the LEL factor will be altered to match)

- At least one of the two operating signals must be switched on.
- Corresponds to the averaging time and is used to calculate the exposure value TWA.
- Only evaluated if the sensor is provided for the purpose.
- Corresponds to the averaging time and is used to calculate the exposure value STEL.

Sensor settings

The following changes can be made to the sensor parameters for the sensors:

Designation	Field
Alarm threshold A1 (in measurement unit)	0 - A2
Alarm threshold A2 (in measurement unit)	A1 – Measuring range limit value
Type of evaluation ¹⁾	Inactive, TWA, STEL, TWA+STEL
Alarm threshold STEL (in measurement unit) ¹⁾	0 – Measuring range limit value
Alarm threshold TWA (in measurement unit) ¹⁾	0 – Measuring range limit value
Calibration interval (days)	0 - 180 (sensor-dependent)
Unit (sensor-dependent)	Vol%, %UEG, %LEL, %LIE, ppm, mbar, ppb, mg/m ³
Gas name: "Ex" (CatEx sensor only)	Yes/No
Automatic fresh air calibration in the charging cradle (CatEx sensor only)	Yes/No

- Only evaluated if the sensor is provided for the purpose.

Testing the parameters

In order to ensure that the values have been correctly transferred to the gas measuring device:

- Press the touch button **Data from X-am 1/2/5x00**
- Check parameters.

3.3.4 Export data memory and display graphically

To read the database of the instrument and display it graphically, the instrument must be connected with a PC.

The installed Dräger GasVision PC software is used for exporting and displaying the database.

- Observe the documentation and online help of the software.

3.4 Running the bump test

3.4.1 Manual implementation without documentation of the results in the instrument memory

- Prepare a test gas cylinder, the volume flow must be 0.5 l/min and the gas concentration must be higher than the alarm threshold concentration that is to be tested.

Example test gas cylinder 68 11 130 = mixed gas with 50 ppm CO, 15 ppm H₂S, 2.5 vol. % CH₄, 18 vol. % O₂

- Connect the test gas cylinder with the calibration cradle (order no. 83 18 752).

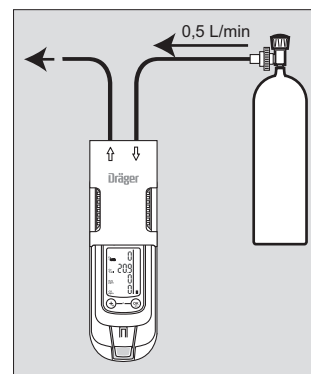

00833966.eps

- Vent the test gas into a fume cupboard or into the open air (with a hose connected to the second connector of the calibration cradle).



WARNING

CSA requirement: carry out a bump test before use. It should be carried out in the measuring range 25-50 % of the full scale value, whereby the displayed measured value may deviate from the actual measured value by 0-20 %. Accuracy may be corrected via calibration.



CAUTION

Never inhale the test gas. Health hazard! Observe the hazard warnings of the relevant Safety Data Sheets.

- Switch on the instrument and insert it into the calibration cradle – press downwards until it engages.
- Open the test gas cylinder valve to let test gas flow over the sensors.

Recommendation: Wait until the instrument displays the test gas concentration with sufficient tolerance – Ex: ±20 % of the test gas concentration¹⁾

O₂: ±0.6 vol. %¹⁾

TÖX: ±20 % of the test gas concentration¹⁾

Wait until at least alarm threshold A1 or A2 has been exceeded, however.

If the alarm thresholds are exceeded, the instrument displays the gas concentration in alternation with » **A1** « or » **A2** « depending on the test gas concentration.

- Close the test gas cylinder valve and remove the instrument from the calibration cradle.



NOTICE

To check the measured value response times, apply t90 test gas to the X-am via the calibration cradle. Check the results in accordance with the information in the table in the enclosed supplementary documentation (order no. 90 33 890) until 90 % of the end display is reached.

1) Upon application of the Dräger mixed gas (order no. 68 11 130) the displays should be within this range.

NOTICE

After the bump test (menu), the display shows a printer icon even if there is no printer connected to the bump test station.

If the concentration has now fallen under the A1 alarm threshold:

- Acknowledge the alarm.

If the displays are outside of the above-mentioned ranges:

- Calibrating/adjusting the instrument, see section 5 on page 16.

3.4.2 Menu implementation with the documentation of results in the instrument memory

The setting to "Quick bump test" or "Extended bump test" is made using the PC software Dräger CC Vision. In the "Quick bump test" a check is carried out as to whether or not the gas concentration has exceeded alarm threshold 1 (with oxygen, the test checks that alarm threshold 1 has not been reached). In the case of the "Extended bump test", a check is made as to whether the gas concentration has reached the set bump test concentration within a tolerance window.

Setting on delivery: Extended bump test.

1. Prepare a test gas cylinder, the volume flow must be 0.5 l/min and the gas concentration must be higher than the alarm threshold concentration that is to be tested.
Example test gas cylinder 68 11 130 = mixed gas with 50 ppm CO, 15 ppm H₂S, 2.5 vol. % CH₄, 18 vol. % O₂
2. Connect the test gas cylinder with the calibration cradle (order no. 83 18 752).
3. Vent the test gas into a fume cupboard or into the open air (with a hose connected to the second connector of the calibration cradle).

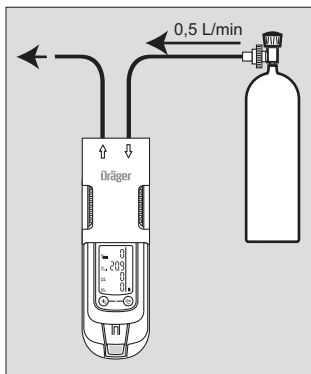

CAUTION

Never inhale the test gas. Health hazard! Observe the hazard warnings of the relevant Safety Data Sheets.

4. Switch on the instrument and insert it into the calibration cradle – press downwards until it engages.

5. Open the Quick menu and select the bump test, page 15.
The current gas concentration values and the special symbol » √0 « (for bump test) flash.
 6. Press the **OK** key to start the bump test.
 7. Open the test gas cylinder valve to let test gas flow over the sensor.
- If gas concentration exceeds the alarm thresholds A 1 or A 2 the corresponding alarm will occur.

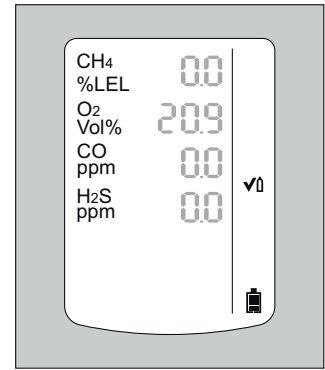

00933366_en.eps

Ending the bump test:

After the set bump test concentration has been reached or a gas alarm has been triggered (with "Quick bump test"):

- The display containing the current gas concentration changes with the display » OK «.
 - The bump test that was carried out is documented with the result and date in the instrument memory.
8. Close the test gas cylinder valve and remove the instrument from the calibration cradle.
- If the concentration values have now fallen under the A1 alarm thresholds, the instrument returns to the measuring mode.
 - If the set bump test concentration is not reached within the set time, an error is issued.
 - The fault message » X « appears and » - - « is displayed instead of the measured value on the faulty measuring channel.
 - In this case, repeat the bump test or calibrate the instrument, page 20.

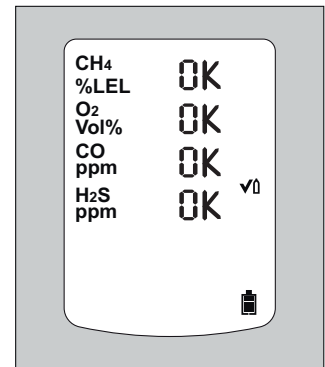

01033366_en.eps

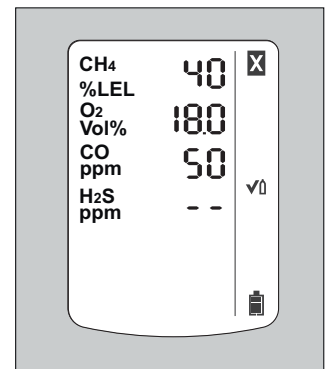

01133366_en.eps

The bump test can also be run automatically. The "Bump Test Station" is required for this function, see section 3.4.3 on page 13.

3.4.3 Automatic implementation with the Bump Test Station

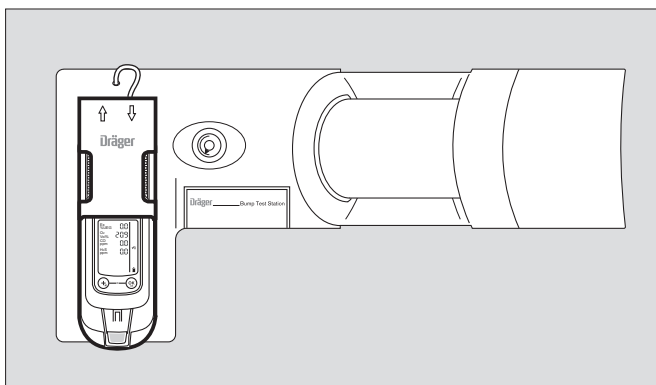

01133366.eps

Prerequisite:

The instrument first needs to be configured for the automatic bump test using the Dräger CC-Vision PC software.

- Activating the instrument for the automatic bump test.
- Adjust the test gas concentration (mixed gas) with the Dräger CC-Vision PC software if it deviates from the following default values – standard on delivery: 50 ppm CO, 15 ppm H₂S, 2.5 vol. % CH₄, 18 vol. % O₂
- Define which measuring channels should participate in the automatic bump test. All measuring channels participate in the bump test by default.

1. Prepare the Bump Test Station according to the instructions.
2. Switch on the instrument and insert it into the receptacle of the Bump Test Station until it engages. The bump test will be started automatically. The special symbol » √ « (for bump test) flashes.

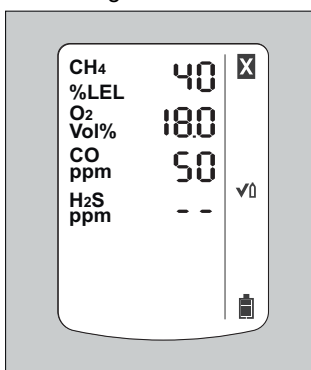

01133366_en.eps

If a gas alarm (quick bump test) is initiated and the set bump test concentration (Accelerated bump test) is reached within the set time, the current gas concentration will be displayed alternately with » OK «.

3. Remove the instrument from the Bump Test Station.
 - If the concentration values have now fallen under the A1 alarm thresholds, the instrument returns to the measuring mode.
 - If there is no alarm during the bump test and the current measurements do not reach the set target concentration ("Accelerated bump test" only), an error is issued.

- The fault message » X « appears and » -- « is displayed instead of the measured value on the faulty measuring channel.
- In this case, repeat the bump test or calibrate the instrument, page 20.

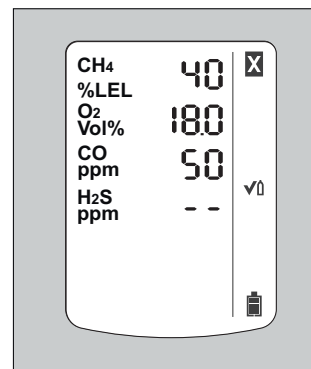

01133366_en.eps

The bump test can also be run manually, see section 3.4.1 on page 11.

The Dräger CC Vision PC software can be used to enable the "Automatic calibration after incorrect bump test" option.

NOTICE

After the bump test, the display shows a printer icon even if there is no printer connected to the bump gas station.

3.5 During operation

- During operation, the measured values for every measured gas are displayed.
- In the event of an alarm, the corresponding displays, including the visual, audible and vibration alarms, are activated see section 6 on page 19.
- If a measuring range is exceeded or not reached, the following displays are shown instead of the measured value display:

- » r r « (measuring range exceeded) or
- » L L « (measuring range not reached) or
- » r J « (blocking alarm).

- In the event of an alarm, the corresponding displays, including the visual, audible and vibration alarms, are activated, see section 6 on page 19.
- If an O₂ sensor is fitted and this sensor measures an O₂ concentration of below 12 vol. %, an error is indicated with » -- « on the ex-channel instead of a measured value if the measured value is below the pre-alarm threshold.
- After the measuring range of the TOX measuring channels has been exceeded temporarily (up to one hour), checking the measuring channels is not necessary.

NOTICE

Special states in which there is no measuring operation (quick menu, calibration menu, warm-up of sensors, password input) are indicated by a visual signal (slow flashing of the alarm LED [diagram]).

If the measuring range is exceeded significantly at the CatEx channel (very high concentration of flammable materials), a blocking alarm is triggered. This CatEx blocking alarm can be acknowledged manually by switching the instrument off and back on again in fresh air.

 **WARNING**

If the DrägerSensor CatEx 125 PR is used in the gas detector, a zero point and sensitivity calibration must be carried out after experiencing an impact load that results in a non-zero display when exposed to fresh air. This warning does not apply if the DrägerSensor CatEx 125 PR Gas is used.

3.6 Identifying alarms

An alarm is displayed visually, audibly and through vibration in a specific pattern.

 **NOTICE**

At low temperatures the legibility of the display can be improved by switching on the backlight.

3.6.1 Concentration pre-alarm A1

Intermittent alarm: 
 Display » **A1** « and measured value alternating:

The pre-alarm A1 is not latching and stops when the concentration has dropped below the alarm threshold A1.

- In case of A1, a single tone is audible and the alarm LED flashes.

Acknowledging the pre-alarm:

- Press the  key. Only the audible alarm and the vibration alarm are switched off.

3.6.2 Concentration main alarm A2

 **WARNING**

Risk of fatal injury! Leave the area immediately. A main alarm is self-latching and cannot be acknowledged or cancelled.

Intermittent alarm: 
 Display » **A2 and measured value** alternating:

- In case of A2, a double tone is audible and the alarm LED flashes twice.

After leaving the area, when the concentration has dropped below the alarm threshold:

- Press the  key. The alarm messages are switched off.

If the measuring range is exceeded significantly on the CatEx channel (very high concentration of flammable materials), a blocking alarm is triggered. This CatEx blocking alarm can be acknowledged manually by switching the instrument off and back on again in fresh air.

3.6.3 STEL/TWA exposure alarm

 **CAUTION**

Health hazard! Leave the area immediately. After this alarm, the deployment of personnel is subject to the relevant national regulations.



 **NOTICE**

The STEL alarm can be triggered with a maximum delay of one minute.

Intermittent alarm: 
 Display » **A2** « and »  « (STEL) or »  « (TWA) and measured value alternating:

- The STEL and TWA alarm cannot be acknowledged or cancelled.
- Switch off the instrument. The values for the exposure evaluation are deleted after the instrument is switched on again.



3.6.4 Battery pre-alarm

Intermittent alarm: 
 Flashing special symbol »  « on the right side of the display:

Acknowledging the pre-alarm:

- Press the  key. Only the audible alarm and the vibration alarm are switched off.
- The battery still lasts min. 20 minutes after the first battery pre-alarm.



3.6.5 Battery main alarm

Intermittent alarm: 
 Flashing special symbol »  « on the right side of the display:

The battery main alarm cannot be acknowledged or cancelled:

- The device automatically switches off after 10 seconds.
- Before the instrument is switched off, the visual, audible and vibration alarms are activated for a short time.

3.6.6 Instrument alarm

Intermittent alarm: 
 Special symbol »  « displayed on the right side of the display:

- The instrument is not ready for operation.
- For corrective measures, see “Replacing the sensors” on page 20 to page 23.
- Contact maintenance or DrägerService to rectify the problem.

4 Menu functions

4.1 Activating the Info mode

- In measuring mode, press the **OK** key for approx. 3 seconds.
- If any warning or fault messages exist, the corresponding information or error codes will be displayed (see section 8 on page 21).
- Press the **OK** key successively for the next display.
- The peak values and the exposition values TWA¹⁾ and STEL¹⁾ are displayed.

I Warning messages are displayed. Numerical codes of warning messages: see section 8.1 on page 21.

OK key

X Fault messages are displayed. Numerical codes of fault messages: see section 8.2 on page 23.

OK key

▲ The peak values = the maximum measured values in the case of, e.g., CO, H₂S, ... or the minimum measured values in the case of O₂ within the storage interval are displayed

OK key

B The average values of the exposures based on a shift of, e.g., 8 hours (TWA) of all the active sensors for the exposure evaluation are displayed

OK key

⌚ The short-term values (STEL) = average values of the concentrations over the average value duration of all the active sensors for the exposure evaluation are displayed

OK key

The instrument is in measuring mode again

- If no key is pressed for 10 seconds, the instrument returns automatically to measuring mode.

4.2 Opening Info-Off Mode

- When the instrument is in a deactivated state, press the **+** key. The name of the gas, measuring unit, and measuring range limit value are displayed for all channels.
- Pressing the **OK** key again exits the Info Off mode (or via timeout).

4.3 Quick Menu

4.3.1 Quick menu functions

✓ Bump test see section 3.4 on page 11

***** Fresh air calibration, see section 5.2 on page 16

▲ Delete peak values, see section 4.3.3 on page 15

⊞ Display pump information, see page 19

⊞ X Activate or deactivate pump, see page 19

4.3.2 Opening the Quick Menu

On delivery, only the fresh air calibration is activated in the Quick Menu. The PC software Dräger CC Vision can be used to activate the bump test for the quick menu and/or the function for displaying and deleting peak values.

1. In measuring mode, press the **+** key three times. If no functions have been activated in the quick menu, the instrument remains in measuring mode.
2. You can select the activated functions of the quick menu by pressing the **+** key.
 - Press the **OK** key to call the selected function.
 - Press the **+** key to cancel the active function and to switch to measuring mode.
 - If no key is pressed for 60 seconds, the instrument returns automatically to measuring mode.

4.3.3 Quick menu "Delete peak values"

After the function has been selected, the current peak values are displayed; the peak values special symbol appears in the display at the same time.

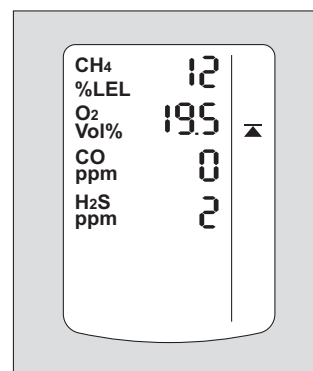

00433366_en.eps

1. The peak values can be deleted by pressing the **OK** key for 5 sec. and the adjacent display appears, for example.
2. Press the **OK** key to end the function.

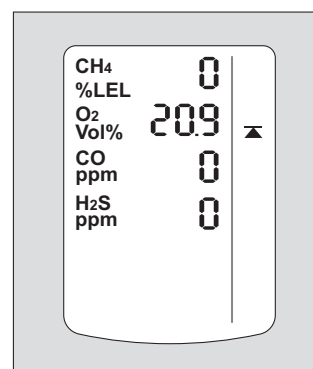

00533366_en.eps

4.4 Calibration Menu

4.4.1 Calibration menu functions

***** Fresh air calibration, see section 5.2 on page 16

1 1-button calibration, see section 5.4 on page 17

⌚ Single gas calibration, see section 5.4.1 on page 18

4.4.2 Open the Calibration Menu

- The calibration menu can only be accessed by entering a password.
Password on delivery: » **001** «
- The default password on delivery can be changed using the PC software Dräger CCVision.

1) Only when activated in the instrument configuration. Delivery status: not activated.

1. In measuring mode, press the **+** key for at least 4 seconds. The function for entering the password is selected. The special symbol » **🔒** « (for the "enter password" function) is displayed.
The display shows » **000** «, with the first digit flashing.
2. Use the **+** key to set the flashing digit.
3. Press the **OK** key, the second digit starts flashing.
4. Use the **+** key to set the flashing digit.
5. Press the **OK** key, the third digit starts flashing.
6. Use the **+** key to set the flashing digit.
7. Press the **OK** key to confirm the password once it has been set completely.
8. The calibration menu functions can now be selected by pressing the **+** key.
 - o Press the **OK** key to call the selected function.
 - o Press the **+** key to cancel the active function.
 - o If no key is pressed for 10 minutes, the instrument automatically returns to measuring mode.

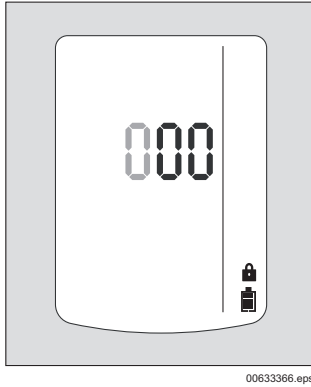

00633366.eps

5 Calibrate instrument

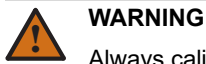

WARNING

Always calibrate the zero-point before span. Otherwise, the calibration will contain errors!



NOTICE

Dräger recommends using the extended bump test for cross calibrations.

- Adjustment may not be possible due to instrument and channel errors.
- Allow the sensors to warm up before the calibration!
- Warming-up time: see instructions for use / data sheets for the Dräger sensors installed (product page for X-am 2500 at www.draeger.com).

5.1 Adjustment interval

- Observe the relevant specifications in the Instructions for Use/data sheets of the Dräger Sensors installed.
- For critical applications, observe the recommendations in EN 60079-29-2¹⁾ or EN 45544-4²⁾ and national regulations. We recommend that you adjust all the channels after 6 months.

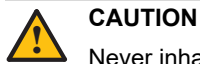

CAUTION

Never inhale the test gas. Health hazard! Observe the hazard warnings of the relevant Safety Data Sheets.

- 1) EN60079-29-2 – Guidelines for selection, installation, use and maintenance of instruments for the detection and measurement of flammable gases and oxygen.
- 2) EN 45544-4 – Electrical instruments for the direct detection and direct concentration measurement of toxic gases and vapours – Part 4: Guide for selection, installation, use and maintenance.

- Improving the zero point accuracy – perform fresh air calibration, page 16.
- Set the sensitivity of all sensors to the value of the test gas – carry out the 1-button calibration, page 17.
- Set the sensitivity of a sensor to the value of the test gas – span calibration/adjustment, page 18.

5.2 Run fresh air calibration

To improve the zero-point accuracy, a fresh air calibration can be carried out.

- Calibrate the instrument to fresh air, free of measured gases or other interfering gases.
- Sensors which have not warmed up or which are faulty prevent a calibration.
 - o In the case of sensors which are in the warm-up phase, the message » **159** « is displayed with the special symbol » **🔒** « (for warning message).
 - o In the case of a sensor or instrument error, the message » **109** « is displayed with the special symbol » **🔒** « (for a fault message).
 - o The message is cleared after 5 seconds and the function is available again in the menu.
- During the fresh air calibration the zero point of all sensors (with the exception of the DrägerSensor XXS O₂) are set to 0.
- In the case of the DrägerSensor XXS O₂, the display is set to 20.9 vol. %.

1. Switch on instrument.
2. Depending on instrument configuration:
 - o Open the Quick menu and select the fresh air calibration function, page 15.
 or
 - o Open the Calibration menu and select the fresh air calibration function, page 15.

- The current gas concentration values flash.
 - When the measured values have stabilized:
3. Press the **OK** key to carry out the fresh air calibration.

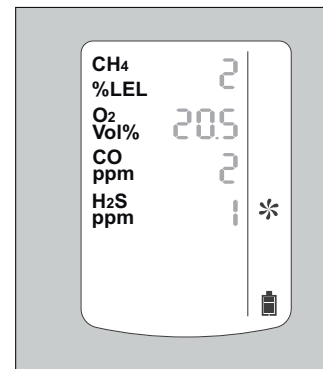

01333366_en.eps

- The display containing the current gas concentration changes with the display » **OK** «.
4. Press the **OK** key to confirm the calibration or wait for approx. 5 seconds.

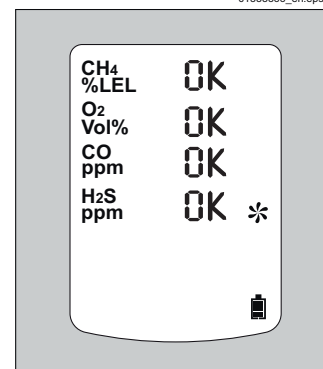

01433366_en.eps

If a fault has occurred during the fresh air calibration:

- The fault message »  « appears and » - - « is displayed for the respective sensor instead of the measured value.
- In this case, repeat the fresh air calibration.
- Replace the sensor if necessary, page 20.

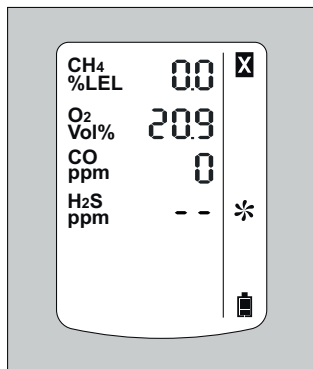

01533366_en.eps

- If a mixed gas with another composition is used, the specified concentration values in the instrument must be changed to the target values of the mixed gas used using the PC software Dräger CC-Vision.

1. Connect the test gas cylinder with the calibration cradle.
2. Vent the test gas into a fume cupboard or into the open air (with a hose connected to the second connector of the calibration cradle).

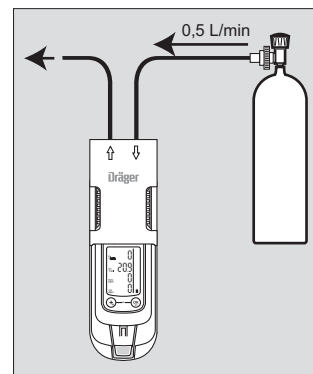

00833366.eps



NOTICE

Automatic surrogate calibration

If the corresponding gas combination and the sensor are approved to do so, an automatic surrogate calibration and tests can be performed using the PC software Dräger CC-Vision¹⁾.

A gas for the bump test, for the adjustment and the measured gas can be set in the gas change wizard in Dräger CC-Vision.

Conversions are performed automatically and no longer need to be made manually.

The settings are also used by the Dräger X-dock.

- 1) The free of charge PC software Dräger CC-Vision can be downloaded from the following web address:
www.draeger.com/software

5.3 Automatic fresh air calibration of the CatEx sensor in the charging cradle

This feature is used to perform an automatic fresh air calibration of the CatEx sensor after placing it in the charging cradle. The feature can be adjusted using the Dräger CC-Vision PC software.



NOTICE

If the automatic fresh air calibration feature of the CatEx sensor is activated, the user must ensure that the charging cradle remains in normal atmosphere (21 vol.% O₂) free of contaminants for the entire duration of the process.

5.4 1-button calibration



NOTICE

If no sensors are approved for the 1-button adjustment via the PC software Dräger CC-Vision, the 1-button adjustment menu function will not be available.

- All sensors approved by the Dräger CC-Vision PC software take part in the 1-button adjustment.
- In the case of the 1-button calibration, the sensitivity of all sensors is set to the value of the test gas. When using test gas cylinder 68 11 130 = mixed gas with 50 ppm CO, 15 ppm H₂S, 2.5 vol. % CH₄, 18 vol. % O₂.



CAUTION

Never inhale the test gas. Health hazard! Observe the hazard warnings of the relevant Safety Data Sheets.



3. Switch on the instrument and insert it into the calibration cradle until it engages.
4. Call the calibration menu, enter the password and select the 1-button calibration function, page 15.
5. Press the  key to start the 1-button calibration.
6. Open the test gas cylinder valve to let test gas flow over the sensor.

The currently displayed measured values start to flash.

The flashing stops after a static measured value has been reached.

The calibration is now carried out automatically.

The displayed measured values change to the values according to the gas supplied.

7. The automatic stability monitoring can be overridden by pressing the  key. A calibration is carried out immediately. If it is detected that no test gas has been supplied, the 1-button calibration is cancelled. The channels then display » n/a «. If only one sensor is included in the 1-button calibration, an adjustment is carried out in any case when the  key is pressed.

When the calibration is completed and the displayed measured values have stabilised:

- The display containing the current gas concentration changes with the display » OK «.
8. Press the  key or wait for 5 seconds to quit the calibration.
- The instrument changes to the measuring mode
9. Close the test gas cylinder valve and remove the instrument from the calibration cradle.

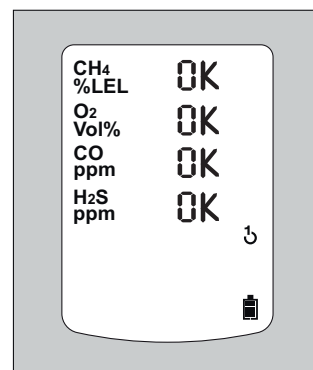

01733366_en.eps

If a fault occurs during the 1-button calibration:

- The fault message » ❌ « appears and » - - « is displayed for the respective sensor instead of the measured value.
- In this case, repeat the 1-button calibration or carry out a single gas calibration, see section 5.4.1 on page 18.
- Replace the sensor if necessary, page 20.

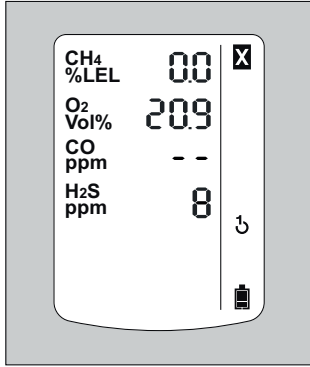

01833366_en.eps

5.4.1 Calibrating the sensitivity for an individual measuring channel

- The span calibration can be carried out specifically for individual sensors.
- In the case of the span calibration, the sensitivity of the selected sensor is set to the value of the test gas used.
- Use a standard test gas.
Allowed test gas concentration:
Ex: 40 to 100 %LEL
O₂ 10 to 25 vol. %
CO: 20 to 999 ppm
H₂S: 5 to 99 ppm
Test gas concentration of other gases: see Instructions for Use for the respective DrägerSensors.

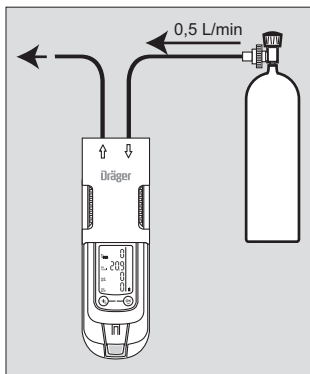

00833366.eps

1. Connect the test gas cylinder with the calibration cradle.
2. Vent the test gas into a fume cupboard or into the open air (with a hose connected to the second connector of the calibration cradle).

CAUTION

Never inhale the test gas. Health hazard! Observe the hazard warnings of the relevant Safety Data Sheets.

3. Switch on the instrument and insert it into the calibration cradle.
4. Press the [+] key and keep it pressed for 5 seconds to open the calibration menu, enter the password and select the single gas calibration function, page 15.
5. Press the **OK** key to start the channel selection.

- The display flashes the gas of the first measuring channel, e.g. » Ex %LEL «.
6. Press the **OK** key to start the calibration function of this measuring channel, or use the **+** key to select another measuring channel (O₂ - vol. %, H₂S - ppm or CO - ppm).

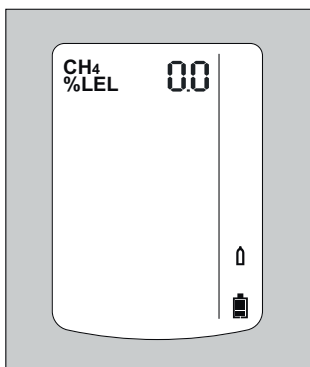

01933366_en.eps

5.4.2 Sensitivity calibration for CatEx

Display on channel selection:

1. Press the **OK** key to start the calibration for the heat tinting or press the **+**-key to select the next sensor.

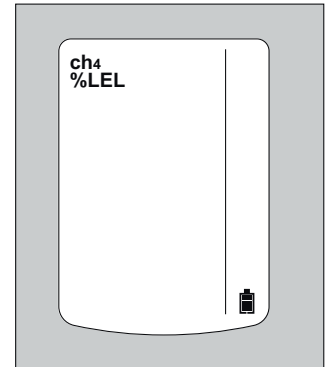

02033366.eps

If the displayed measurement value is stable:

2. Press the **OK** key to perform the calibration.
The display containing the current gas concentration changes with the display » OK «.

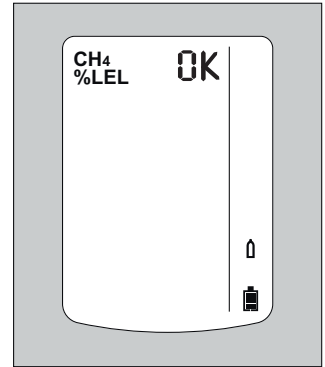

02433366_en.eps

3. Press the **OK** key or wait for approx. 5 seconds to end the calibration of this measuring channel.
The next measuring channel is offered for calibration.
After the calibration of the last measuring channel, the device changes to measuring mode.

4. Close the test gas cylinder valve and remove the device from the calibration cradle.

If a fault occurred during the span calibration.

- The fault message » ❌ « appears and » - - « is displayed for the sensor instead of the measured value.
- In this case, repeat the calibration.
- If necessary, replace the sensor, page 20.

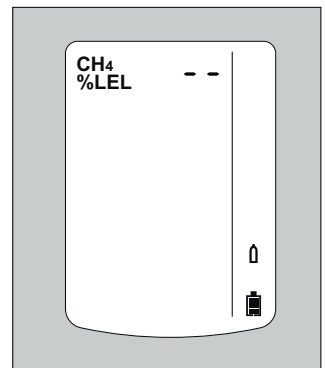

02533366_en.eps

5. Press the **OK** key to confirm the calibration gas concentration or use the [+] key to change the calibration gas concentration and complete the process by pressing the **OK** key.
The measurement value flashes.
6. Open the test gas cylinder valve to let test gas flow over the sensor.
The displayed, flashing measurement value changes to the value according to the supplied test gas.
7. Press the **+**-key to select the next sensor.

Notice for the adjustment of the ex-channel to nonane as a measuring gas:

- During the calibration of the ex-channel, propane can be used as a substitute calibration gas.
- When using propane to adjust the ex-channel to nonane, the display must be set to twice the used test gas concentration.

Notice for the use in subsurface mining:

- For the calibration of the ex-channel to the measuring gas methane, the display of the instrument must be set to a value of 5 % (relative) higher than the used test gas concentration.

Automatic fresh air calibration in the charging cradle (CatEx sensor only):

Calibrate the gas detector to fresh air, free of measured gases or other interfering gases. If the function is selected, a fresh air calibration of the CatEx sensor is performed automatically as soon as the gas detector is inserted in the charging cradle. This function can be selected or disabled using the CC-Vision PC software.



No calibration takes place if the warm-up is not yet complete:

- Alarm LED is illuminated red.
- The acoustic signal sounds twice followed by three short tones and the gas detector switches off.

Once the fresh air calibration has been successfully completed:

- Alarm LED is illuminated red.
- The acoustic signal sounds once followed by three short tones and the gas detector switches off.

If a fault has occurred during the fresh air calibration:

- The fault message  appears and  is displayed for the respective sensor instead of the measured value.
- In this case, repeat the fresh air calibration. If necessary, have the sensor replaced by qualified personnel.

5.5 Calibration with the X-dock maintenance station

The modular X-dock 5300/6300/6600 maintenance station (see order list) can be used to automatically perform calibrations and bump tests of several gas warning devices in parallel and independently of each other. More detailed information can be found in the corresponding instructions for use (see the X-dock product page at www.draeger.com).

6 Operation with pump**Observe the following when performing measurements using the pump**

- Perform visual inspection of the probe, if necessary.
- Wait for the flushing time to end. Flush the Dräger sampling hose or Dräger probes prior to each measurement with the air sample to be measured.

The flushing phase is necessary to minimize or eliminate any effects associated with the use of a sampling hose or a probe, e.g. memory effects, dead volume.

The duration of the flushing phase depends on factors such as type and concentration of the gas or vapour to be measured, material, length, diameter and age of the sampling hose or probe. As a rule of thumb, a typical flushing time of 3 seconds per metre can be assumed for a sampling hose (factory-new, dry, clean). This flushing time applies in addition to the sensor response time (see instructions for use of the gas detector used).

Example:

The flushing time for a 10 m hose is approx. 30 seconds. The sensor response time is approx. 60 seconds in addition. The overall time before reading the gas detector therefore is approx. 90 seconds.

The flow alarm is delayed by 10 to 30 seconds, depending on the hose length.

6.1 Performing a measurement with the Dräger X-am Pump

Required accessories (see section 14 on page 28):

- Dräger X-am Pump
- Sampling hose and probes

Pump symbols:

 Pump battery 100 % charged

 Warning for pump (Gas detector can no longer detect pump.)

 Remaining charge of pump battery: 2/3

 Leak test: Block suction inlet

 Remaining charge of pump battery: 1/3



 Leak test: Release suction inlet

 Pump battery discharged

Commissioning and performing the measurement:

- See instructions for use of the Dräger X-am Pump.

Viewing pump information:

1. Open the quick menu (see "Opening the Quick Menu" on page 15).
2. Select  and confirm with the  button. The following pump information will be displayed:
 - serial number
 - pump runtime
 - pump battery charge
 - pump status (activated or deactivated)
3. Press the  button to return to measuring mode.





**WARNING**

No measurement!
If the pump is connected but deactivated, the gas detector is not ready to measure. The red LEDs on the gas detector flash.

**WARNING**

Impairment of measuring accuracy!
After measuring high nonane concentrations (>20 %LEL), the measuring accuracy for nonane is impaired. The pump is not suited for the continuous measuring of high nonane concentrations.

Activating or deactivating the pump:

1. Open the quick menu (see “Opening the Quick Menu” on page 15).
2. Select  or  and activate or deactivate the pump by pressing the  button.
3. Press the  button to return to measuring mode.

6.2 Performing a measurement with a manual pump adapter and rubber ball pump

Required accessories (see section 14 on page 28):

- Manual pump adapter
- Rubber ball pump
- Sampling hose
- Probes

Commissioning and performing the measurement:

- See instructions for use of the accessories used.

7 Replacing the sensors



CAUTION

Damage to components!

There are components in the instrument that are sensitive to electric charge. Before opening the instrument to replace the sensor, ensure that the person performing the work is earthed to avoid damage to the device. Earthing can be safely ensured, e. g. via an ESD workstation (electrostatic discharge).



NOTICE

To open the instrument, unfasten the casing screws using a screwdriver (Torx T6).

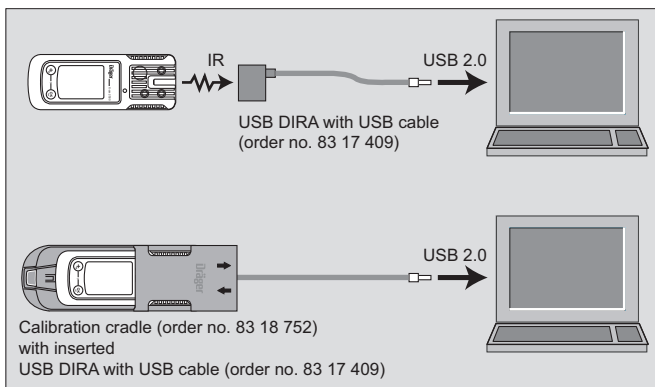

- To replace the sensors of the instrument, connect the instrument with a PC.
- Replace the sensors using the PC program Dräger CC Vision.

Next:

- Conduct the fresh air calibration page 16.
- and then:
- Calibrating sensitivity:
either
perform 1-button calibration, page 17
or
run sensitivity calibration, see page 18.

8 Troubleshooting

Fault	Cause	Remedy
Not possible to switch on the instrument	Discharged power pack	Charge the power pack, page 6.
	Discharged alkaline batteries	Insert new alkaline batteries, page 20.
Not possible to switch off the instrument	The instrument is not set to measuring mode	Select measuring mode.
	The instrument is configured to "Disable prohibited"	Configure the instrument to "Disable allowed" with Dräger CC Vision.
Display » -- «	Measuring range calibrated/adjusted incorrectly	Recalibrate/adjust the measuring range, page 20.
	Electronics or sensors defective	Must be repaired by Service.

List of the numerical codes of the warning and fault messages in the info mode, see page 15.

8.1 Warning messages

Special symbol » ⓘ « and displayed numerical code:	Cause	Remedy
152	Customer's service life counter about to elapse	Reset the service life counter using Dräger CC Vision.
153	Database 90 % full	Read the database soon and clear memory afterwards.
154	Database full	Read the database and clear memory.
155	Interval for bump test elapsed	Conduct the bump test page 20.
156	Battery pre-alarm of X-am Pump	Recharge the battery soon. The battery will last for at least 20 minutes after the first battery pre-alarm.
159	Calibration not possible. The menu function cannot be carried out because of a message which is preventing the function (e.g. sensors in warm-up phase).	Determine the message code via the info menu and switch it off, if necessary.
251	DrägerSensor CatEx 125 PR warming up	Wait until warm-up time is complete.
252	DrägerSensor CatEx 125 PR warming up	Wait until warm-up time is complete.
253	Ex concentration has drifted into the negative range	Conduct the fresh air calibration page 16.
254	The temperature is too high	Operate the instrument within the allowed temperature range.
255	The temperature is too low	Operate the instrument within the allowed temperature range.
256	Calibration interval for DrägerSensor CatEx 125 PR has expired	Perform sensitivity calibration for DrägerSensor CatEx 125 PR, page 18.
257	Alarm threshold A2 is set to greater than 60 %LEL	Set alarm threshold to less than 60 %LEL.
271	Heat conductance calibration interval for DrägerSensor CatEx 125 PR has expired	Perform sensitivity calibration for DrägerSensor CatEx 125 PR, page 18.
272	Sensor is switched off due to excess gas	Restart the device
351	DrägerSensor XXS EC1 is warming up	Wait until warm-up time is complete.
352	DrägerSensor XXS EC1 is warming up	Wait until warm-up time is complete.
353	EC1 concentration has drifted into the negative range	Conduct the fresh air calibration page 16.

Special symbol » ⓘ « and displayed numerical code:	Cause	Remedy
354	The temperature is too high	Operate the instrument within the allowed temperature range.
355	The temperature is too low	Operate the instrument within the allowed temperature range.
356	The calibration interval for DrägerSensor XXS EC1 has elapsed	Run sensitivity calibration for DrägerSensor XXS EC1, page 18.
357	Alarm threshold A2 is set to greater than 60 %LEL	Set alarm threshold to less than 60 %LEL.
451	DrägerSensor XXS EC2 in the warm-up phase	Wait until warm-up time is complete.
452	DrägerSensor XXS EC2 in the warm-up phase	Wait until warm-up time is complete.
453	EC2 concentration has drifted into the negative range	Conduct the fresh air calibration page 16.
454	The temperature is too high	Operate the instrument within the allowed temperature range.
455	The temperature is too low	Operate the instrument within the allowed temperature range.
456	The calibration interval for DrägerSensor XXS EC2 has elapsed	Run sensitivity calibration for DrägerSensor XXS EC 2, page 18.
457	Alarm threshold A2 is set to greater than 60 %LEL	Set alarm threshold to less than 60 %LEL.
551	DrägerSensor XXS EC3 in the warm-up phase	Wait until warm-up time is complete.
552	DrägerSensor XXS EC3 in the warm-up phase	Wait until warm-up time is complete.
553	EC3 concentration has drifted into the negative range	Conduct the fresh air calibration page 16.
554	The temperature is too high	Operate the instrument within the allowed temperature range.
555	The temperature is too low	Operate the instrument within the allowed temperature range.
556	The calibration interval for DrägerSensor XXS EC3 has elapsed	Run sensitivity calibration for DrägerSensor XXS EC 3, page 18.
557	Alarm threshold A2 is set to greater than 60 %LEL	Set alarm threshold to less than 60 %LEL.
575	Calibration interval for the compensation channel has elapsed	Adjust the sensitivity of the compensation channel.
576	Calibration required because of overgassing.	Adjust the sensitivity of the compensation channel.
651	DrägerSensor XXS EC 4 in the warm-up phase	Wait until warm-up time is complete.
652	DrägerSensor XXS EC 4 in the warm-up phase	Wait until warm-up time is complete.
653	EC 4 concentration has drifted into the negative range	Conduct the fresh air calibration page 16.
654	The temperature is too high	Operate the instrument within the allowed temperature range.
655	The temperature is too low	Operate the instrument within the allowed temperature range.
656	The calibration interval for DrägerSensor XXS EC 4 has elapsed	Run sensitivity calibration for DrägerSensor XXS EC 4, page 18.
657	Alarm threshold A2 is set to greater than 60 %LEL	Set alarm threshold to less than 60 %LEL.

8.2 Fault message

Special symbol » ☒ « and displayed numerical code:	Cause	Remedy
102	The customer's service life counter has elapsed	Reset the service life counter using Dräger CC Vision.
103	The instrument is defective	The instrument must be repaired by Service.
104	Check sum error program code	The instrument must be repaired by Service.
105	Bump test interval elapsed	Run the bump test page 13.
106	The calibration interval has elapsed (at least 1 calibration interval has elapsed)	Run sensitivity calibration, see page 17 and/or page 18.
107	Bump test error (at least 1 channel has a bump test error)	Run bump test, page 13 or run sensitivity calibration, page 17 and/or page 18.
108	The instrument is defective	The instrument must be repaired by Service.
109	The menu function cannot be carried out because of an error	Determine the error code via the info menu and switch it off, if necessary.
111	Faulty alarm element test: Alarm light	Repeat alarm element test using X-dock.
112	Faulty alarm element test: Alarm horn	Repeat alarm element test using X-dock.
113	Faulty alarm element test: Vibration motor	Repeat alarm element test using X-dock.
114	Defective parameter check	Correct parameters and repeat test using X-dock
115	Instrument deactivated by X-dock	Instrument activated using X-dock.
116	Faulty software update	The instrument must be repaired by Service.
117	User parameters not feasible	Check configuration of user parameters and adjust
118	Flow alarm of X-am Pump	Check the gas circuit for obstructions and replace filters if necessary.
121	Overvoltage on X-am Pump	Contact DrägerService.
122	Battery main alarm of X-am Pump	Charge pump.
201	No valid zero point calibration of the DrägerSensor CatEx 125 PR	Conduct the fresh air calibration page 16.
202	No valid sensitivity calibration of the DrägerSensor CatEx 125 PR	Run sensitivity calibration, see page 17 and/or page 18.
203	Measurement from DrägerSensor CatEx 125 PR is in negative range	Conduct the fresh air calibration page 16.
204	DrägerSensor CatEx 125 PR not plugged in or faulty	Check DrägerSensor CatEx 125 PR, page 20
205	Error during bump test of DrägerSensor CatEx 125 PR	Repeat bump test, where necessary, calibrate or replace the DrägerSensor CatEx 125 PR, page 20.
207	Faulty rise time test	Repeat rise time test using X-dock.
208	User parameters not feasible	Check configuration of user parameters and adjust
218	Blocking alarm not plausible.	Calibrate the sensor.
221	Too little oxygen to operate the DrägerSensor CatEx 125 PR	Operate sensor in an environment with at least 8 vol. % O ₂ .
222	No valid zero point calibration of the DrägerSensor CatEx 125 PR for heat conduction	Conduct the fresh air calibration page 16.
223	No valid sensitivity calibration of the DrägerSensor CatEx 125 PR for heat conduction	Run heat conduction sensitivity calibration, see page 17 and/or page 18.
224	Instrument incorrectly configured by Dräger CC-Vision.	Change sensor for applicable channel with Dräger CC-Vision.

Special symbol » ☒ « and displayed numerical code:	Cause	Remedy
301	No valid zero point calibration of the Dräger Sensor XXS EC1	Conduct the fresh air calibration page 16.
302	No valid sensitivity calibration of the Dräger Sensor XXS EC1	Run sensitivity calibration, see page 18 and/or fresh air calibration, page 16.
303	The measured value of DrägerSensor XXS EC 1 is in the negative range	Conduct the fresh air calibration page 16.
304	DrägerSensor XXS EC1 is not inserted or faulty	Check Dräger Sensor XXS EC1, page 20.
305	Error in bump test of Dräger Sensor XXS EC1	Repeat bump test, calibrate or replace DrägerSensor XXS EC1, if necessary page 20.
307	Faulty rise time test	Repeat rise time test using X-dock.
308	User parameters not feasible	Check configuration of user parameters and adjust
324	Instrument incorrectly configured by Dräger CC-Vision.	Change sensor for applicable channel with Dräger CC-Vision.
326	Error during warm-up acceleration Dräger Sensor XXS EC1	Disconnect and reconnect power pack or replace the sensor. Sensor must not be loaded with gas within the first 5 minutes.

401	No valid zero point calibration of the Dräger Sensor XXS EC2	Conduct the fresh air calibration page 16.
402	No valid sensitivity calibration of the Dräger Sensor XXS EC2	Run sensitivity calibration, page 18.
403	The measured value of DrägerSensor XXS EC2 is in the negative range	Conduct the fresh air calibration page 16.
404	DrägerSensor XXS EC2 is not inserted or faulty	Check Dräger Sensor XXS EC2, page 20.
405	Error in bump test of Dräger Sensor XXS EC2	Repeat function test, calibrate or replace Dräger Sensor XXS EC2, if necessary page 20.
406	Faulty filter test	Repeat filter test using X-dock.
407	Faulty rise time test	Repeat rise time test using X-dock.
408	User parameters not feasible	Check configuration of user parameters and adjust
424	Instrument incorrectly configured by Dräger CC-Vision.	Change sensor for applicable channel with Dräger CC-Vision.
426	Error during warm-up acceleration Dräger Sensor XXS EC2	Disconnect and reconnect power pack or replace the sensor. Sensor must not be loaded with gas within the first 5 minutes.

501	No valid zero point calibration of the Dräger Sensor XXS EC3	Conduct the fresh air calibration page 16.
502	No valid sensitivity calibration of the Dräger Sensor XXS EC3	Run sensitivity calibration, page 18.
503	The measured value of DrägerSensor XXS EC3 is in the negative range	Conduct the fresh air calibration page 16.
504	DrägerSensor XXS EC3 is not inserted or faulty	Check Dräger Sensor XXS EC3, page 20.
505	Error in bump test of Dräger Sensor XXS EC3	Repeat bump test, calibrate or replace DrägerSensor XXS EC3, if necessary page 20.
506	Faulty filter test	Repeat filter test using X-dock.
507	Faulty rise time test	Repeat rise time test using X-dock.
508	User parameters not feasible	Check configuration of user parameters and adjust
524	Instrument incorrectly configured by Dräger CC-Vision.	Change sensor for applicable channel with Dräger CC-Vision.
525	No valid sensitivity calibration for the compensation channel	Carry out span calibration for compensation electrode.

Special symbol » ☒ « and displayed numerical code:	Cause	Remedy
526	Error during warm-up acceleration Dräger Sensor XXS EC3	Disconnect and reconnect power pack or replace the sensor. Sensor must not be loaded with gas within the first 5 minutes.
601	No valid zero point calibration of the Dräger Sensor XXS EC4	Conduct the fresh air calibration page 16.
602	No valid sensitivity calibration of the Dräger Sensor XXS EC4	Run sensitivity calibration, page 18.
603	The measured value of Dräger Sensor XXS EC4 is in the negative range	Conduct the fresh air calibration page 16.
604	DrägerSensor XXS EC4 is not inserted or faulty	Check Dräger Sensor XXS EC4, page 20.
605	Error in bump test of Dräger Sensor XXS EC4	Repeat bump test, calibrate or replace DrägerSensor XXS EC4, if necessary page 20.
606	Faulty filter test	Repeat filter test using X-dock.
607	Faulty rise time test	Repeat rise time test using X-dock.
608	User parameters not feasible	Check configuration of user parameters and adjust
624	Instrument incorrectly configured by Dräger CC-Vision.	Change sensor for applicable channel with Dräger CC-Vision.
626	Error during warm-up acceleration Dräger Sensor XXS EC4	Disconnect and reconnect power pack or replace the sensor. Sensor must not be loaded with gas within the first 5 minutes.

9 Maintenance

9.1 Maintenance table

The instrument should be inspected and maintained by suitably qualified persons annually. Consult:

- EN 60079-29-2 – Guide for the selection, installation, use and maintenance of apparatus for the detection and measurement of combustible gases or oxygen
- EN 45544-4 – Electrical apparatus used for the direct detection and direct concentration measurement of toxic gases and vapours - Part 4: Guide for selection, installation, use and maintenance
- national regulations

Recommended calibration interval for measuring channels Ex, O₂, H₂S, SO₂, NO₂ and CO: 6 months.

NOTICE

Calibration intervals of other gases: see Instructions for Use of the respective DrägerSensors.

- Depending on instrument configuration:
 - Replace the alkaline batteries or charge the battery – see section 3.1.2 on page 7 – after each use, at the latest after the battery alarm has been triggered or after 2 weeks.
- Calibrating the instrument – see section 5 on page 16.
 - At regular intervals, according to the sensors used and the operating conditions. For sensor-specific calibration data, refer to the Instructions for Use/data sheets of the sensors used¹⁾.
 - Before you carry out safety-related relevant measurements, the zero point and sensitivity of the instruments should be tested in accordance with national regulations.
- Inspection by suitably qualified persons – every year.
 - The inspection intervals must be established in each individual case and shortened if necessary, depending on technical safety considerations, engineering conditions, and the technical requirements of the equipment.
 - We recommend that a service agreement be concluded with Dräger and that repairs also be carried out by them.
- Replace the sensors, page 20 – if necessary, when it is not possible to calibrate the sensors any more.

10 Cleaning



CAUTION

Abrasive cleaning tools (brushes etc.), cleaning agents and cleaning solvents can destroy the sensor diaphragm of the upper cradle.



For information on suitable cleaning agents and disinfectants and their specifications, see document 9100081 at www.draeger.com/IFU.

- The instrument does not need any special care.
- Dirt and deposits can be removed from the instrument by washing it with cold water. A sponge can be used for wiping if necessary.
- Carefully dry the instrument with a cloth.

11 Storage

- Dräger recommends storing the instrument in the charger module (order no. 83 18 639).
- Dräger recommends checking the charge of the power supply at least every three weeks if the instrument is not stored in the charger module.

12 Disposal



This product must not be disposed of as municipal waste. This is indicated by the adjacent icon.

You can return this product to Dräger free of charge. For information please contact the national sales organisations and Dräger.



Batteries and rechargeable batteries must not be disposed of as municipal waste. This is indicated by the adjacent icon. Collect and dispose of batteries and rechargeable batteries at battery collection centres, in accordance with applicable regulations.

Electrochemical sensors



WARNING

Acid burn risk!
Do not throw into fire or open with force.



As with batteries, dispose of as special waste in line with local waste disposal regulations. Further information can be obtained from the relevant local authority and from appropriate waste disposal companies.

The DrägerSensor CatEx 125 PR should be disposed of as electronics waste.

1) Instructions for use/data sheets for the Dräger sensors can be downloaded from the product page for the X-am 2500 on the following website: www.draeger.com. See also the enclosed instructions for use and data sheets for the sensors used.

13 Technical data

13.1 X-am 2500

Ambient conditions:	
during operation and storage	<p>Temperature class T4 (–20 to +50 °C): NiMH power packs type: HBT 0000, HBT 0100 Power pack type: ABT 0100 with alkaline single cell type: Duracell Procell MN 1500¹⁾, Duracell Plus Power MN 1500¹⁾</p> <p>Temperature class T3 (–20 to +40 °C): Power pack type: ABT 0100 with NiMH single cell type: GP 180AAHC¹⁾ with alkaline single cell type: Panasonic LR6 Powerline</p> <p>Temperature class T3 (0 to +40 °C): Power pack type: ABT 0100 with alkaline single cell type: Varta 4006¹⁾, Varta 4106¹⁾</p>
Temperature across a short period:	<p>–40 to +50 °C Maximum of 15 minutes with NiMH power pack T4 (HBT 0000) or T4 HC (HBT 0100) Prerequisite: storage of the instrument at room temperature (+20 °C) for at least 60 minutes in advance.</p>
Air pressure	700 to 1300 hPa
Humidity	10 to 90 % (short-term up to 95 %) relative humidity
Storage time	
X-am 2500	1 year
Sensors	1 year
Position of use	any
Instrument data	
Protection class	IP 67 for instruments with sensors
Alarm volume	Typically 90 dB (A) at 30 cm distance
Operating time:	
Alkaline battery	Typically 12 hours under normal conditions
NiMH power pack:	
T4 (type HBT 0000)	Typically 12 hours under normal conditions
T4 HC (type HBT 0100)	Typically 13 hours under normal conditions
Dimensions	approx. 130 mm x 48 mm x 44 mm (H x W x D)
Weight	approx. 220 g to 250 g
Refresh interval for display and 1 s signals	

1) Not part of the BVS10 ATEX E 080X and PFG 10 G 001X technical suitability test.

14 Order list

Name and description	Order no.
Dräger X-am 2500 Unlimited multi gas detector for 1 to 4 gases with replaceable sensors. With selectable special calibration. Default calibration for the ex-sensor: methane. Order no. 83 23 900 with default alarm thresholds that can be adjusted specifically for each country, all other versions have a default setting that is valid for all countries.	
Dräger X-am 2500 standard instrument:	
Dräger X-am 2500 Ex	83 23 910
Dräger X-am 2500 Ex, O ₂	83 23 912
Dräger X-am 2500 Ex, O ₂ , H ₂ S LC	83 23 914
Dräger X-am 2500 Ex, O ₂ , CO	83 23 916
Dräger X-am 2500 Ex, O ₂ , CO, H ₂ S LC	83 23 918
Basic instrument with selectable special calibrations, including a calibration certificate	83 23 900
Power packs:	
NiMH power pack T4 (type HBT 0000)	83 18 704
NiMH power pack T4 HC (type HBT 0100)	83 22 244
Battery holder ABT 0100	83 22 237
Alkaline batteries T3 (2x) ¹⁾	83 22 239
Alkaline batteries T4 (2x) ¹⁾	83 22 240
Battery and charger set (includes NiMH power pack T4, charger module for Dräger X-am 1/2/5000 and plug-in power supply unit) ⁵⁾	83 18 785
Chargers:	
Charging adapter for Dräger X-am 1/2/5000	83 26 101
Charger module for Dräger X-am 1/2/5000	83 18 639
Plug-in power supply unit in connection with adapter 83 25 736 for a maximum of 20 X-am 1/2/5000 charging modules	83 21 850 83 25 736
Plug-in power supply unit (worldwide) for max. 5 Dräger X-am 1/2/5000 charger modules	83 16 994
Plug-in power supply unit (worldwide) for 1 Dräger X-am 1/2/5000 charger module	83 16 997
Vehicle connection, 12 V/24 V for Dräger X-am 1/2/5000 charger module	45 30 057
Vehicle mount for 1 Dräger X-am 1/2/5000 charger module	83 18 779
Accessories The accessories are not part of BVS10 ATEX E 080X and PFG 10 G 001X.	

Name and description	Order no.
Pump accessories:	
Dräger Pump X-am 1/2/5000	83 19 400
Case for Dräger Pump X-am 1/2/5000	83 19 385
Dräger X-am Pump	83 27 100
Case for Dräger X-am Pump	83 27 104
USB power supply unit (for Dräger X-am Pump)	83 27 102
USB cable (for Dräger X-am Pump)	83 27 108
Rubber ball pump	68 01 933
Manual pump adapter	83 19 195
Filter set for X-am 1/2/5000	83 19 364
Extension hoses and probes (excerpt):	
Measuring probe ²⁾ , 1.5 m	64 08 239
Telescopic probe ²⁾ , plug-in	68 01 954
Telescopic probe ²⁾ 100 with accessories	83 16 530
Telescopic probe ²⁾ 150 stainless steel	83 16 533
Bar probe ²⁾ 90	83 16 532
3 mm tube connection set ²⁾	83 27 641
Floating probe (3 mm), EPP, 3 m hose ²⁾	83 25 831
Floating probe (3 mm), EPP, 10 m hose ²⁾	83 25 832
Fluoroelastomer hose (3 mm) incl. adapter, 5 m ²⁾	83 25 705
Fluoroelastomer hose (3 mm) incl. adapter, 10 m ²⁾	83 25 706
Fluoroelastomer hose (3 mm) incl. adapter, 20 m ²⁾	83 25 707
Fluoroelastomer hose ³⁾ (3 mm), sold by the metre, specify length when ordering	83 25 837
Hose (3 mm), PVC, sold by the metre, specify length when ordering	83 25 838
Hose (rubber, 3 mm), CR-NR, sold by the metre, specify length when ordering	83 25 839
Accessories for recording the measured values and for configuration:	
Dräger CC-Vision (free full version available at www.draeger.com/software)	
Dräger GasVision (trial version available at www.draeger.com/software)	
Dräger GasVision licence key (to upgrade from trial version to full version)	83 25 646
USB DIRA with USB cable (USB infrared adapter for communication between Dräger X-am 1/2/5000 and PC)	83 17 409

Name and description	Order no.
Calibration accessories:	
Dräger X-dock, e.g. X-dock 5300 X-am 125	83 21 880
Bump test station, incl. mixed-gas cylinder	83 19 130
Calibration cradle for Dräger X-am 1/2/5000	83 18 752
Mixed gas cylinder 2.5 vol.% CH ₄ , 18 vol.% O ₂ , 15 ppm H ₂ S, 50 ppm CO	68 11 130
Test gas cylinder, propane, 0.9 vol.% C ₃ H ₈ in air	68 11 118
On-demand controller	83 16 556
Standard controller	68 10 397
Other accessories:	
Additional rubber housing boot	83 21 506
Leather carrying case	83 18 755
Spare parts	
DrägerSensor CatEx 125 PR, 0 to 100 %LEL	68 12 950
DrägerSensor CatEx 125 PR Gas, 0 to 100 %LEL	68 13 080
DrägerSensor XXS O ₂ , 0 to 25 vol.% ⁴⁾	68 10 881
DrägerSensor XXS CO LC, 0 to 2000 ppm ⁴⁾	68 13 210
DrägerSensor XXS H ₂ S LC, 0 to 100 ppm ⁴⁾	68 11 525
DrägerSensor XXS NO ₂ , 0 to 50 ppm	68 10 884
DrägerSensor XXS SO ₂ , 0 to 100 ppm	68 10 885

- 1) Not part of the BVS 10 ATEX E 080X and PFG 10 G 001X technical suitability tests.
- 2) This accessory is optimised for the Dräger X-am Pump (market launch in 2017) (for hoses with 3 mm inner diameter).
- 3) 3 mm tube connection set (order no. 83 27 641) required.
- 4) Expected sensor life time: O₂ and CO >5 years, CatEx > 3 years.
Older type sensors (order no. 68 108 82 for CO or order no. 68 10 883 for H₂S) can be registered in the instrument, but not configured.
- 5) Sale of these parts to be discontinued at the end of 2020

© **Dräger Safety AG & Co. KGaA**
Revalstraße 1
23560 Lübeck, Germany
Tel +49 451 882 0
Fax +49 451 882 20 80
www.draeger.com

90 33 366 - TH 4638.205 en
© Dräger Safety AG & Co. KGaA
Edition 08 - December 2020 (Edition 01 - November 2012)
Subject to alteration