

Technical manual

X-am[®] 2800 / X-am[®] 5800

MQG 02*0

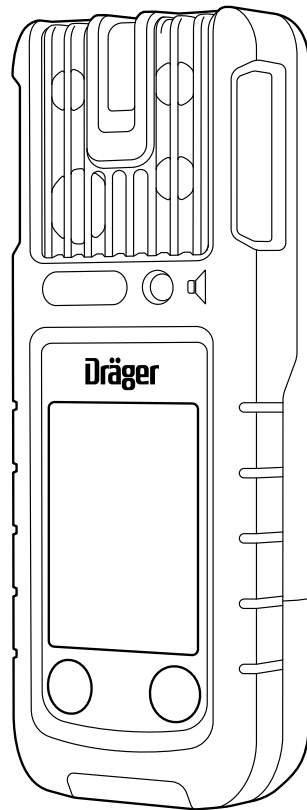

More languages available
for download at draeger.com/ifu

Contents

1	Safety-related information	4
1.1	Basic safety information.....	4
1.2	Use in areas subject to explosion hazards	4
2	Conventions in this document	6
2.1	Meaning of the warning notes.....	6
2.2	Trade marks.....	6
2.3	Glossary.....	6
2.4	Abbreviations	7
3	Description	7
3.1	Product overview	7
3.2	Intended use	8
3.3	Approvals.....	8
3.4	GPL (General Public License)	8
4	Operation	9
4.1	Symbol explanations.....	9
4.2	Signalling concept.....	9
4.2.1	Acoustic life signal	9
4.2.2	Visual life signal and D-Light	10
4.3	Switch the gas detector on or off	10
4.3.1	Switching on the gas detector	10
4.3.2	Switching off the gas detector	11
4.4	Preparations for operation	11
4.5	Connecting a gas detector to a smartphone.....	12
4.6	During operation	13
4.6.1	Measuring mode.....	14
4.6.2	Alarms	15
4.6.3	Special state	15
4.6.4	Protection alarm	15
4.6.5	Automatic distress signal.....	15
4.6.6	Panic alarm.....	16
4.7	Calling up the Quick menu.....	16
4.8	Opening information	16
4.8.1	Opening device information.....	16
4.8.2	Opening channel information when the device is switched off.....	17
4.9	Activating automatic measuring range switchover.....	17
5	Troubleshooting	17
5.1	Error.....	18
5.2	Warnings.....	20
5.3	Instructions	22
6	Maintenance	22
6.1	Maintenance intervals.....	22

6.2	Calibration intervals	23
6.3	Test gases	23
6.4	Performing the bump test	23
6.5	Perform a bump test with the Bump Test Station	25
6.6	Check response time (t90).....	26
6.7	Calibrating the gas detector.....	26
6.7.1	Notes on calibration.....	26
6.7.2	Performing a fresh air calibration.....	27
6.7.3	Carrying out a single-gas calibration	28
6.7.4	Carrying out a mixed gas calibration	29
6.8	Charging the battery	30
6.9	Charge the battery with the multicharger.....	31
6.10	Replacing the battery.....	33
6.11	Exchanging, adding or removing a sensor	33
6.12	Cleaning the PID lamp (X-am 5800 only)	38
6.13	Exchange the device components.....	39
6.13.1	Opening the gas detector	39
6.13.2	RFID transponder (optional).....	40
6.13.3	Horn resonator.....	41
6.14	Cleaning.....	42
7	Configuration.....	42
7.1	Standard gas configuration for X-am 2800	42
7.2	Standard gas configuration for X-am 5800	43
7.3	Configuring the gas detector.....	44
7.3.1	Configuring the gas detector with the PC and reading the data memory.....	44
8	Device settings	45
8.1	Factory settings	45
8.2	Device and sensor settings.....	46
8.3	Alarm settings (factory setting)	48
9	Storage.....	48
10	Disposal	49
11	Technical data	49
11.1	Gas detector	49
11.2	Dimensions	50
11.3	Dimensions for vehicle mount.....	51

1 Safety-related information

 The calibration certificate can be downloaded from <https://www.draeger.com/productioncertificates>.
The manufacturer's certificate can be requested from Dräger.

1.1 Basic safety information

- Before using the product, carefully read through these instructions for use, the instructions for use provided with the associated products and the general instructions for use for sensors (9023657).
- Strictly follow the instructions for use. The user must fully understand and strictly observe the instructions. Use the product only for the purposes specified in the Intended use section of this document.
- Do not dispose of the instructions for use. Ensure that they are retained and appropriately used by the product user.
- Only trained and competent users are permitted to use this product.
- Comply with all local and national rules and regulations associated with this product (e.g. IEC 60079-14, EN 60079-29-2, EN 45544-4, IEC 62990-2).
- Only specialist, trained personnel are permitted to check, repair and maintain the product as described in these instructions for use and the technical manual. Further maintenance work that is not detailed in these instructions for use or in the technical manual must only be carried out by Dräger or personnel qualified by Dräger. Dräger recommend a Dräger service contract for all maintenance activities.
- Only use genuine Dräger spare parts and accessories when performing maintenance work, or the proper functioning of the product may be impaired.
- Do not use a faulty or incomplete product. Do not modify the product.
- Notify Dräger in the event of any component fault or failure.
- Substitution of components may impair the intrinsic safety of the product.
- Electrical pairing with devices which are not listed in these instructions for use should only be done following consultation with the respective manufacturers or an expert.

1.2 Use in areas subject to explosion hazards

To reduce the risk of ignition of a flammable or explosive atmosphere, strictly observe the following warnings:

Use in areas subject to explosion hazards

Devices or components for use in explosion-hazard areas which have been tested and approved according to national, European or international explosion protection regulations may only be used under the conditions specified in the approval and with consideration of the relevant legal regulations. The devices or components may not be modified in any manner. The use of faulty or incomplete parts is forbidden. The appropriate regulations must be observed at all times when carrying out repairs on these devices or components.

Oxygen enriched atmospheres

Explosion protection is not ensured in oxygen enriched atmospheres (>21 Vol% O₂).

- ▶ Remove the device from the explosion-hazard area.

Oxygen deficient atmospheres

The CatEx sensor may display false readings and incorrect measured values when used for measurements in an oxygen deficient atmosphere (<12 Vol% O₂). In this case the CatEx sensor cannot provide a reliable measurement.

- ▶ The CatEx sensor is intended to measure flammable gases and vapours mixed with air (i.e. O₂ content ≈ 21 Vol%). If the O₂ content falls below 12 Vol% and an operational O₂ sensor is available in the gas detector, a channel error is triggered on the CatEx channel due to oxygen deficiency.
- ▶ A CatEx sensor should preferably be operated with an active XXS O₂ or O₂ PR sensor so that oxygen deficiency can be evaluated by the gas detector.
- ▶ Remove the gas detector from the area and discontinue measurement.

Incorrect calibration

CAUTION: An incorrect calibration leads to incorrect measured values.

- ▶ CSA requirement (Canadian Standard Association): The sensitivity must be checked daily before first using the device, with a known concentration of the gas to be measured that corresponds to 25 to 50 % of the final concentration. The accuracy must be 0 to +20 % of the actual value. The accuracy can be corrected by calibration.

NOTICE

Damage to the CatEx sensor!

Fractions of catalytic poisons in the measuring gas (e.g. volatile silicon, sulphur, heavy metal compounds or halogenated hydrocarbon) can damage the Cat Ex sensor.

- ▶ If the CatEx sensor can no longer be calibrated to the target concentration, replace the sensor.

WARNING

Risk of explosion!

If the CatEx sensor is exposed to hydrogen and low temperatures (< -10 °C) for a long time (> 1 h), measured values that are too low may be displayed. This also applies if hydrogen is being measured but the measured gas set is not hydrogen.



- ▶ The CatEx sensor should be set to the measured gas “hydrogen” for regular and planned measurements of hydrogen. Measuring tasks which last less than 30 min. are not affected by this.

 Increased hydrogen concentrations within the measuring range of the DrägerSensor XXS H₂ HC and CatEx sensor may trigger false alarms by additively influencing Dräger sensors XXS H₂S and XXS CO, XXS H₂S-LC and XXS CO-LC, and negatively influencing DrägerSensor XXS O₂ and XXS O₂ PR.

2 Conventions in this document

2.1 Meaning of the warning notes

The following warning notes are used in this document to notify users of possible dangers. The meanings of the warning notes are defined as follows:

Alert icon	Signal word	Consequences in case of nonob-servance
	WARNING	Indicates a potentially hazardous situation. If not avoided, it could result in death or serious injury.
	CAUTION	Indicates a potentially hazardous situation. If not avoided, it could result in physical injury. It may also be used to alert against unsafe practices.
	NOTICE	Indicates a potentially hazardous situation. If not avoided, it could result in damage to the product or environment.

2.2 Trade marks

Brand	Brand owner
X-am [®]	Dräger
Bluetooth [®]	Bluetooth SIG, Inc.

The brands listed are only registered in certain countries and not necessarily in the country in which this material is sold.

2.3 Glossary

Term	Description
Life signal	A periodic optical (green LED) and/or acoustic signal.
Monitoring	Monitoring without pump (diffusion)
Capture range	The capture range refers to a measured value range within which minor variations in measured values (such as signal noise, variations in concentration) do not cause variations in the display. Measured values outside the capture range will be displayed with the actual measured value.
Peak	Peak value
Quick bump test	Test for alarm triggering
Extended bump test	Test for accuracy
Special state	If a special state is signalled, the user is not warned of gas concentrations which may be dangerous. The following device features are special states: Initial set-up/configuration with the PC, switch-on sequence, menu, bump test and calibration, warm-up 1 of the sensors, device error, measuring channel error.

Term	Description
D-Light	The D-Light feature allows the user to check and indicate compliance with certain settings.
Physical sensors	The CatEx, IR, and PID sensor types are designated as physical sensors. There are also the electrochemical sensors.

2.4 Abbreviations

Abbreviation	Explanation
A1	Pre-alarm
A2	Main alarm
PID	Photoionization detector
STEL	Short time exposure limit, threshold of an exposition over a short period of time (generally 15 minutes).
TWA	Time weighted average, average shift values are generally limited to eight hours exposure per day per workplace for 5 days a week during a work lifetime. Observe the national definition of the occupational exposure limit.

3 Description

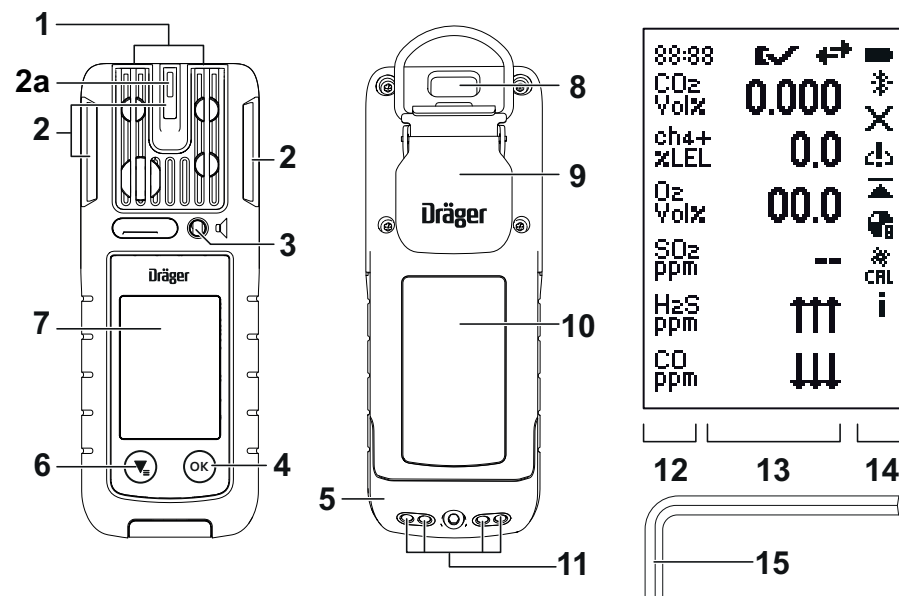

3.1 Product overview



Graphic A

1 Gas inlet

8 IR interface

Graphic A	
2 Alarm LED	9 Fastening clip
2a D-Light	10 Name plate
3 Horn	11 Charging contacts
4  key	12 Measured gas display
5 Power pack	13 Measuring value display
6  key	14 Special symbols
7 Display	15 Allen key (2 mm; alternative: Torx T8)

Marking added-signal channels (X-am 5800 only):

Feature	Shown in display
Toxic Twins	HCN+
CO H2 compensation	CO+
H2 added signal	ch4+ ¹⁾

1) Example illustration with methane (CH4) for IR sensors.

3.2 Intended use

Dräger X-am 2800/X-am 5800 is a portable gas detector for continuous monitoring of the concentration of several gases in the ambient air within the working area and in explosion-hazard areas.

The gas detector is suitable for both indoor and outdoor applications for which an IP 68 degree of protection and certified explosion protection (see name plate) are sufficient. The gas detector is not suitable for use under jets of water.

3.3 Approvals

A copy of the name plate, the declaration of conformity, and the sensor data relevant for measurement purposes are provided in the enclosed supplementary documentation (part no. 9300308) or at www.draeger.com/ifu.

 The name plate on the gas detector must not be damaged or concealed. If the name plate is damaged, it must be replaced by Dräger Service.

FCC:

The radio license information can be found in the information on the device. For further information see: "Opening device information", page 16.

3.4 GPL (General Public License)

Depending on their configuration, Dräger products which use software use Open Source software. This is regularly subject to special licensing conditions which take precedence in their scope. Several Open Source software licensing conditions may apply in a single Dräger product, which then apply respectively to the associated software components. Further information on the Open Source software used in this products is available on the following Internet page: www.draeger.com/opensource.

4 Operation

4.1 Symbol explanations

Symbol	Explanation
	Bump test
	Fresh air calibration
	Single-gas calibration
	Mixed gas calibration
	Measurement range exceeded
	Readings below the measurement range
	Peak value
	Protection alarm (only CatEx sensor)
	Channel error
	Compliance with bump test interval.
	Warning message The gas detector can be operated normally. If the warning message is still displayed after operation, the gas detector requires maintenance.
	Fault message The gas detector or measuring channel is not ready to measure and requires maintenance.
	Information message
	STEL alarm message
	TWA alarm message
	Gas detector in maintenance mode
	Bluetooth® activated
	(flashing) Bluetooth® connection lost
	Bluetooth® connection established
	(dashes flashing) Gas detector ready for coupling
	Battery state of charge
	Display pump information

4.2 Signalling concept

4.2.1 Acoustic life signal

A periodic acoustic signal indicates that the device is operational. The acoustic life signal can be deactivated using the Dräger CC-Vision PC software.

4.2.2 Visual life signal and D-Light

The visual life signal can be extended by the D-Light feature with activated interval check. An activated D-Light feature allows the user to also check and indicate compliance with certain settings.

The D-Light feature can be activated using the Dräger CC-Vision PC software.

Visual life signal with deactivated D-Light:

The green LED flashing periodically (every 5 s) indicates:

- Measurement is active
- There is no device or channel error, no gas alarm and no special state

If one of the above conditions is not met, the LED will flash according to the alarm settings.

Visual life signal with activated D-Light:

All the visual life signal conditions apply. In addition, the following settings are checked:

- Evaluation of bump test intervals activated and complied with (factory setting) or evaluation of the calibration intervals active and complied with
- Usage interval complied with

If one of these two conditions is not met, the green LED will flash approx. every 60 s instead of every 5 s.

4.3 Switch the gas detector on or off

4.3.1 Switching on the gas detector

WARNING

Incorrect device feature/settings!

Incorrect device features/settings may mean that alarms and dangers are not detected.



- ▶ Before every use, check whether the display elements, the alarm features and information are displayed correctly. If one of the items listed above does not function correctly or is incorrect, do not use the gas detector and have it inspected.

 No alarms are issued during the warm-up phase!

1. Hold down the  button for approx. 3 s. The display shows the following screens one after the other.
 - ⇒ Countdown
 - ⇒ The switch-on sequence and the warm-up phase of the sensors start.
 - ⇒ Display test
 - ⇒ Start screen
 - ⇒ Firmware version
 - ⇒ Alarm element test (LEDs, alarm signal and vibration alarm)
 - ⇒ Customer-specific information screen (optional and can be configured with the Dräger CC Vision PC software)
 - ⇒ Measuring channel, sensor type, alarm thresholds, STEL, TWA (if configured) and LEL factor (if available)
 - ⇒ Any expired bump test or calibration interval as well as early warnings (if configured)
 - ⇒ Measured value display

4.3.2 Switching off the gas detector

 When the gas detector is placed in the charging cradle, it switches off automatically (only when the automatic distress signal is deactivated).

1. Hold down  and  simultaneously until the displayed countdown has finished.
 - ⇒ The visual, acoustic and vibration alarms activate briefly.
 - ⇒ The gas detector is switched off.

4.4 Preparations for operation

WARNING

Serious damage to health

An incorrect calibration can lead to incorrect measured values, which may result in serious damage to health.

- ▶ Before performing safety-relevant measurements, check the calibration by means of a bump test, calibrate as necessary, and check all alarm elements. If national regulations exist, the bump test must be performed in accordance with these regulations.

 The gas detector should be worn for personal monitoring in the proximity of the breathing zone.

Dräger recommend using the clip to attach the gas detector to clothing either on your collar or breast pocket. If gases are expected in a closed space that are (much) heavier than air (e.g. CO₂), then the gas detector can be worn in a lower position, e.g. on your belt or at your hip.

 The gas detector has magnetic switches. Do not put any magnets in the immediate proximity of the gas detector (e.g. name badges with magnetic holders). This could trigger features (e.g. bump test) on the gas detector.

1. Switch on the gas detector. The current measured values are shown in the display.
2. Observe warnings, error messages and special states.
3. Verify that the gas inlet openings and membranes are clean, freely accessible, dry and undamaged.
4. Check that the date and time are set correctly.

4.5 Connecting a gas detector to a smartphone

The gas detector can be connected to a suitable smartphone via Bluetooth®. The Bluetooth® feature and the GATT (Generic Attribute Profile) interface (subject to licensing) can be activated via the CC-Vision PC software or¹⁾ the Quick menu.

Data transmitted via Bluetooth® can be used for additional safety measures. However, the data does not replace primary on-site measures by the gas detector. The alarm on the gas detector is decisive. An important consideration is that a mobile network and WLAN reception are not always available or can be interrupted.

For specific features, Dräger offers apps that can be installed on a suitable smartphone or tablet. A license may be required under certain circumstances. For detailed information on connecting via Bluetooth® also refer to the instructions for use of the smartphone used.

Prerequisites

- Bluetooth® is activated on the gas detector and the smartphone.

WARNING

Risk of explosion

The use of an unsuitable smartphone in an explosion-hazard area may lead to the ignition of flammable or explosive atmospheres.

- ▶ The smartphone must be suitable and approved for use in explosion-hazard areas.

 The Bluetooth® feature is not part of the technical suitability test and may only be used in countries for which approval is available. Contact Dräger if you have any questions about availability.

 Contamination of the gas detector or shielding elements (e.g. case) can reduce the Bluetooth® range.

 Failure of the Bluetooth® communication of the gas detector is to be expected in the vicinity of strong transmitters in the range of the 2.4 GHz band.

 When connecting a new smartphone, the connection that is currently stored is deleted during this process.

1. Switch on the gas detector.
2. Call up the Quick menu: Press  3x in measuring mode.
3. Select Bluetooth® connection and confirm.

1) To do this, the feature must be activated in the Quick menu.

4. Select the gas detector on the smartphone:
 - a. Short name of the gas detector in the Android/iOS Bluetooth® menu.
 - b. Part number and serial number in optional Dräger app.
A 6-digit number is displayed on the smartphone and on the gas detector.
5. Check that the numeric code on both devices match and, if they match, confirm on both devices. The devices must be coupled within 20 s otherwise the numeric code will become invalid.
- ✓ Coupling of the devices is complete.

Once a connection has been successfully established, it is saved and the two devices are automatically connected in the future (adjustable via the CC-Vision PC software).

If the connection is lost, the gas detector automatically tries to establish a new connection.

A connection to the Dräger Connectivity Hub is established automatically if the gas detector is registered to the same tenant as the Dräger Connectivity Hub. For more information, see the Dräger Connectivity Hub instructions for use.

A short tone sounds to indicate that a connection is being established.

A double tone indicates that the connection has been terminated.

4.6 During operation

⚠ WARNING

Danger to life and/or risk of explosion!

The following alarms indicate a danger to life and/or risk of explosion:

- A2 alarm
- STEL or TWA alarm
- Device/channel error
- ▶ Immediately leave the hazard area.

⚠ WARNING

Incorrect measured values!

Only for diffusion mode: If water seals the gas inlets on the gas detector (e.g. in heavy rain or if the gas detector is submerged in water), incorrect measured values may be returned.

- ▶ With the display facing downward, shake the gas detector to remove the water.

⚠ WARNING

Incorrect measured values!

A different reading may be shown if the gas detector experiences a considerable impact or a significant vibration.

- ▶ When using a CatEx or IR sensor (depending on the gas detector type), a calibration of zero-point and sensitivity must be carried out after an impact load that results in a fresh air display not equal to zero.
-

⚠ CAUTION

The volume of the horn is reduced!

If water gets into the opening on the horn (e.g. by immersing the gas detector in water or due to heavy rain), the volume of the horn can be significantly reduced.

▶ With the display facing downward, shake the gas detector to remove the water.

i Only using Bluetooth® or API applications is insufficient for raising the alarm in safety-critical applications. Raising the alarm on the gas detector is decisive. Contact Dräger for a description of the API interface.

i Dräger recommends limiting the usage time at temperatures below -20 °C, as the rechargeable battery life and the display may be restricted.

i At temperatures below -25 °C, there may be limitations to what is shown on the display. Dräger then recommends only using the alarm elements as a display.

⚠ WARNING

High readings outside of the LEL display range or a protection alarm may indicate an explosive concentration.

If the concentrations of combustible gases are too high, this may be the result of a lack of O₂.

The IP degrees of protection do not extend to instances in which the equipment detects a gas during or after its exposure to these conditions. In the case of dust deposits and contact with water by immersion or a jet of water, check the calibration and functional integrity of the device.

The PEAK, STEL and TWA evaluations are interrupted if a menu is selected.

The STEL measurement is interrupted when the pump is connected and restarted when the pump is removed.

The TWA measurement is paused when the pump is connected and continues when the pump is removed.

The STEL values are reset when a bump test is started, irrespective of whether the bump test is successful or is cancelled.

If the gas detector is used for offshore applications, it must be kept at least 5 m away from compasses.

4.6.1 Measuring mode

In normal measuring mode, the measured values are displayed for each measured gas. The life signal sounds at regular intervals (configurable), and the green LED flashes (e.g. visual life signal or D-light feature).

If a measuring range is exceeded or not reached, the respective symbol is displayed instead of the measured value.

If, in measuring mode, an event (e.g. an alarm) occurs, the respective symbol is displayed in the status bar (after the event is acknowledged, if applicable) alternating with the measured values.

4.6.2 Alarms

In the event of an alarm, corresponding displays, the visual alarm, vibration alarm as well as the audible alarm are activated. For further information, see the following chapter: "Alarm settings (factory setting)", page 48

To acknowledge an alarm:

1. Select .

4.6.3 Special state

If a special state is active, the life signal is deactivated. Special states are indicated by the following visual signals:

- Flashing yellow LED – special state 'warm-up 1'
- Continuously lit yellow LED – special state 'general'

No alarms are issued in a special state.

If there is a potential error, the special state is ended when this is resolved. If the gas detector is error-free, the special state is ended when it switches to normal measuring mode. Otherwise, the special state ends independently after approximately 1 minute.

4.6.4 Protection alarm

The blocking alarm protects the CatEx sensor.

If the measuring range is exceeded significantly at the CatEx channel (very high concentration of flammable substances), a blocking alarm is triggered. This CatEx blocking alarm can be acknowledge by switching the gas detector off and then on again in fresh air.

If the gas detector cannot be switched off because the A2 alarm is active and the switch-off mode in CC-Vision is set to "Switching off not allowed during A2", remove the power pack or place the gas detector in the charging cradle and allow it to switch off automatically (only when the automatic distress signal is deactivated).

4.6.5 Automatic distress signal

 When the automatic distress signal is activated, the gas detector is no longer deactivated automatically when it is placed in the charging cradle.

The automatic distress signal can be activated via Dräger CC-Vision.

When the automatic distress signal is activated, an alarm is triggered in measuring mode if the gas detector is not moved for an adjustable period.

Default setting: Pre-alarm: 20 s, main alarm: another 10 s

 The automatic distress signal can be paused for 15 min via the Quick menu.

To confirm a pre-alarm:

1. Press any key or move the gas detector.

To confirm a main alarm:



1. Press any key.

4.6.6 Panic alarm

A panic alarm can be triggered in order to request assistance in an emergency and if there is a danger to persons or property.

If there is an active Bluetooth connection to Dräger Gas Detection Connect, a panic alarm can be forwarded and assistance requested in this way.

To trigger a panic alarm:

1. Press  for approx. 3 s in measuring mode.
⇒  appears and a visual, acoustic and haptic emergency signal is emitted.







Further steps

To disable a panic alarm, press  again for 3 s.



4.7 Calling up the Quick menu

The Dräger CC-Vision software can be used to save preferred features in the Quick menu.

Possible features:

-  Fresh air calibration¹⁾
-  Bump test
-  Delete peak values
-  Bluetooth[®] connection
-  Bluetooth[®] information
-  Display pump information (only when the pump adapter is connected)
-  Pause/continue automatic distress signal

To call up the Quick menu:

1. Press  3x in measuring mode.
2. Press  to scroll through the available features.
3. Press  to call the selected feature.

4.8 Opening information



4.8.1 Opening device information

This feature can be used to call up device, channel, firmware and Bluetooth[®] (e-Label) information and peak evaluations.



If any warning or fault messages exist, the corresponding note and fault codes are displayed. Further information on the individual fault codes for service and maintenance is provided in the technical manual.

 If no key is pressed for 10 s, the gas detector automatically returns to measuring mode.

1) The fresh air calibration/zero calibration is not supported by the CO₂ channel of the infrared sensor and XXS O₃. Zero calibration of these sensors can be undertaken using the Dräger CC-Vision PC software. A suitable zero gas that is free from carbon dioxide and ozone (e.g. N₂) is required for this.

1. Press  3x in measuring mode.
⇒ Device information is displayed.
2. Press  to scroll through the available device information.

4.8.2 Opening channel information when the device is switched off

1. Press  for at least 1 s when the device is switched off.
⇒ Channel information is displayed.
2. Press  to end the display (after 3 s the display is automatically ended).

4.9 Activating automatic measuring range switchover

 The automatic measuring range switchover is not part of the technical suitability test.

WARNING

Risk of explosion!

Only for CatEx sensors: The full-range mode only applies for methane in the air. Any other gas composition has an impact on the measured signal, may cause an incorrect display of the results and may cause permanent damage to the sensor.

► Only use the full-range mode to measure methane in the air.

The automatic measuring range switchover can only be activated for the DrägerSensor CatEx SR sensor (order no. 6851900) with methane as the measured gas.

If automatic measuring range switchover is activated, only the X-am 5800 has an automatic switch to volume percent range when 100 % LEL methane is exceeded.

If the “No measured values in Vol% range” feature has been selected, the over range in %LEL will continue to be shown instead of the measured values in the volume percent range.

When returning to the range of <100 % LEL methane, the measured value display alternates with the indicator (circular arrow) during the transition.

Prerequisite:

- The %LEL (heat tone) and Vol% (heat transfer) measuring ranges are calibrated.
1. Activate automatic measuring range switchover with the Dräger CC-Vision PC software.
 2. Where applicable, select the “No measured values in Vol% range” feature with the Dräger CC-Vision PC software.

5 Troubleshooting

If the following remedial measures are unsuccessful, contact DrägerService.











If an error code is shown when an error occurs, report this to DrägerService. Most codes are accompanied by an instruction symbol which briefly explains the warning or error without using text.









5.1 Error



The sensor technology that can be used depends on the device type.

The first digit of the code represents the sensor channel:

Code	Sensor channel	Code	Sensor channel
2xx	DrägerSensor CatEx SR	6xx	EC4
3xx	EC1	7xx	IR
4xx	EC2	8xx	IR
5xx	EC3	9xx	PID

Code	Cause	Remedy
102	 Customer's period of use counter has expired.	Reset period of use counter with Dräger CC-Vision.
103	 Gas detector defective.	Contact DrägerService.
104	Program code checksum error	Contact DrägerService.
105	 Bump test interval expired	Carry out bump test.
108	 Gas detector defective.	Contact DrägerService.
109	 Menu function cannot be performed as an error has occurred.	Determine fault code using the Info menu and disable if necessary.
110	Alarm element test faulty.	Repeat the alarm element test with X-dock.
111	Faulty alarm element test: Alarm LED	Repeat the alarm element test with X-dock.
112	Faulty alarm element test: Horn	Repeat the alarm element test with X-dock.
113	Faulty alarm element test: Vibration motor	Repeat the alarm element test with X-dock.
115	 Gas detector disabled by X-dock.	Activate device with X-dock.
118	X-am pump flow alarm	Check gas circuit for leaks.
119	Hardware error (pump)	Contact DrägerService.
120	X-am pump battery main alarm	Charge pump.
121	Battery main alarm	Charge the gas detector.
122	 Internal device error	Switch the gas detector off and on again. Contact DrägerService.
123	 Hardware error (reference voltage source)	Contact DrägerService.
124	 Device temperature too high.	Operate gas detector within permitted temperature range.
125	 Device temperature too low.	Operate gas detector within permitted temperature range.
126	Gas detector defective.	Contact DrägerService.

Code	Cause	Remedy
129	Motionless detector faulty	Switch the gas detector off and then on again; replace the sensor.
132	Self-test failed	Contact DrägerService.
141	 Vibration motor defective.	Contact DrägerService.
148	Ambient pressure too low.	Operate gas detector within permitted ambient pressure range.
149	DB version invalid for this firmware.	Repeat the software update or contact DrägerService.
x01	 No valid zero-point calibration.	Carry out a fresh air calibration / zero-point calibration.
x02	 No valid span calibration.	Carry out the span calibration.
x03	 Measured value of sensor in negative range.	Carry out a fresh air calibration / zero-point calibration.
x04	Sensor not connected or faulty.	Connect sensor or check contacts.
x05	Error during bump test.	Repeat the bump test.
x07	 Faulty rise time test.	Repeat the rise time test with X-dock.
x08	Invalid value	
x09	Channel error	Contact DrägerService.
x11	Sensor hardware error	Switch the gas detector off and then on again; replace the sensor.
x12	 Calibration interval has expired.	Carry out the span calibration.
x13	Measurement invalid.	Reinaugurate sensor.
x14	Sensor hardware error	Replace the sensor.
x16	 Thermal conduction calibration interval for DrägerSensor CatEx SR has expired.	Perform span calibration for DrägerSensor CatEx SR.
x18	Protection alarm not plausible.	Calibrate sensor.
x19	If a channel error occurs on the CO-channel when activating ToxicTwins, this error will be set on the HCN channel.	Recalibrate the CO-channel or replace the sensor.
x21	Insufficient oxygen for the correct functionality of the CatEx sensor.	Operate the gas detector in atmospheric conditions.
x22	 Zero calibration failed (CatEx thermal conduction range).	Carry out a fresh air calibration / zero-point calibration.
x23	 Span calibration failed (CatEx thermal conduction range).	Carry out the span calibration.
x24	Gas detector incorrectly configured by Dräger CC-Vision.	Replace sensor for affected channel with Dräger CC-Vision.
x26	Error during intake acceleration.	Remove and reinsert the power pack or replace the sensor. Gas may not be applied to the sensor during the first 5 minutes.

Code	Cause	Remedy
x32	Error in the compensation channel.	Switch the gas detector off and then on again; replace the sensor.
x33	Error in a connected channel.	Switch the gas detector off and then on again; replace the sensor.
x38	Condensation on sensor	Acclimatise the gas detector. Move the gas detector into a condensation-free environment.
x39	Sensor software error	Carry out a firmware update; contact DrägerService.
x36	 Device temperature too high.	Operate gas detector within permitted temperature range.
x37	 Device temperature too low.	Operate gas detector within permitted temperature range.
x42	Sensor current too low.	Switch the gas detector off and then on again; replace the sensor.



5.2















Warnings

The sensor technology that can be used depends on the device type.

The first digit of the code represents the sensor channel:

Code	Sensor channel	Code	Sensor channel
2xx	DrägerSensor CatEx SR	6xx	EC4
3xx	EC1	7xx	IR
4xx	EC2	8xx	IR
5xx	EC3	9xx	PID

Code	Cause	Remedy
150	Ambient pressure too high.	Operate gas detector within permitted ambient pressure range.
152	 Customer's period of use counter will expire soon.	Reset period of use counter with Dräger CC-Vision.
156	Ambient pressure too low.	Operate gas detector within permitted ambient pressure range.
157	X-am pump battery pre-alarm	Charge the battery as soon as possible. The battery will continue for at least another 20 minutes after the first battery pre-alarm.
159	 Calibration not possible. Menu function cannot be performed as a notice exists that prevents the function (e.g. sensors warming up).	Determine notice code using the Info menu and disable if necessary.
163	 Period of use expired.	Reset period of use counter with Dräger CC-Vision.
164	Bluetooth function limited.	Switch the gas detector off and on again. Contact DrägerService.

Code	Cause	Remedy
165	Error sent from Bluetooth control.	Switch the gas detector off and then on again / Contact Dräger-Service.
175	Bluetooth connection interrupted.	Reconnect the device.
176	Subsystem software version too old.	Carry out a software update.
182	 Device temperature too high.	Operate gas detector within permitted temperature range.
183	 Device temperature too low.	Operate gas detector within permitted temperature range.
185	Battery pre-alarm	Charge or replace battery.
x50	Lamp intensity too low.	Clean the lamp or replace the sensor.
x51	 Sensor warming up (warm-up 1). Followed by measurement standby, bump test standby	Wait until warm-up time is complete.
x52	 Sensor warming up (warm-up 2). Followed by calibration standby	Wait until warm-up time is complete.
x53	 Value negative.	Perform a fresh air calibration.
x54	 Temperature too high.	Operate gas detector within permitted temperature range.
x55	 Temperature too low.	Operate gas detector within permitted temperature range.
x56	 Calibration interval close to expiry.	Carry out the span calibration.
x69	 Bump test expired.	Carry out bump test.
x70	 Bump test interval expires soon.	Carry out bump test.
x71	 Span calibration close to expiry (CatEx thermal conduction range).	Carry out the span calibration.
x72	 Sensor switched off due to overgassing.	Restart the gas detector.
x73	 Calibration expired (CatEx thermal conduction range).	Carry out the span calibration.
x77	 Calibration interval has expired.	Carry out the span calibration.
x78	Sensor software version is too old.	Update the sensor.
x80	Sensor life time has expired.	Replace the sensor as soon as possible.
x82	Deviation after zero calibration of the IR sensor.	Carry out span calibration for IR sensor.

5.3 Instructions

Code	Cause
30	 Wait for fresh air.
90	No sensor selected for this feature.

6 Maintenance

WARNING

Risk of explosion!

To reduce the risk of ignition of a flammable or explosive atmosphere, observe the following:

- ▶ Do not open the gas detector in explosion-hazard areas.

WARNING

Danger to health!

Test gas may damage health if inhaled.

- ▶ Do not inhale the test gas. Observe the hazard warnings of the relevant Safety Data Sheets and the instructions for use of the gas detector! Observe the national regulations when defining calibration intervals.

 The operator of the product must protect the configuration software for the gas detector (e.g. Dräger CC-Vision) with a password against unauthorized access as part of their user management. The password must be changed regularly, at least once per month.

 Contact DrägerService to replace the display and printed circuit board.

6.1 Maintenance intervals

Check	Interval
Inspections and maintenance by experts.	Every 12 months
Check signalling elements with the signal test	Automatically whenever the device is started

For inspection and maintenance, see e.g.:

- EN/IEC 60079-29-2 – Gas detectors - Selection, installation, use and maintenance of detectors for flammable gases and oxygen
- EN 45544-4 – Electrical apparatus used for the direct detection and direct concentration measurement of toxic gases and vapours - Part 4: Guide for selection, installation, use and maintenance
- National regulations

6.2 Calibration intervals

Observe the relevant specifications in the DrägerSensor® & Gas Detectors Manual and in the instructions for use/data sheets of the Dräger sensors installed.

Recommended calibration intervals for DrägerSensors:

DrägerSensor®	Calibration interval
CatEx SR, XXS O ₂ , XXS H ₂ S LC, XXS CO LC, XXS SO ₂ , XXS NO ₂	Every 6 months ¹⁾
CatEx SR, measured gas: H ₂	Every 4 months ¹⁾
PID HC neo ²⁾	Depending on the conditions of use, daily calibration may be necessary. The interval may be extended in increments to up to 30 days ³⁾ if no deviations occur during calibration in successive tests.
Other DrägerSensors	See the special data sheets for the respective sensors.

- 1) The recommended calibration interval can be extended to 12 months if it is ensured that an advanced bump test (tolerance: max. ±20 %) is carried out and passed before use in safety-relevant measurements. The advanced bump test checks the existing sensitivity.
- 2) If the gas detector is used with the PID HC neo sensor in the X-zone 5500/5800, a bump test must be carried out after no more than 7 days. This applies in particular if the X-zone 5500/5800 is continuously powered by the Ex power supply. A bump test must always be carried out when using the gas detector in the X-zone if the location of the X-zone changes.
- 3) Alternatively, a calibration interval of 6 months may be implemented. This requires the use of the X-dock maintenance station to conduct a reading test of the type 'Extended bump test' every working day with a tolerance of 10 % based on the target concentration. If the gas detector fails this test, it must be calibrated.

 National regulations may stipulate shorter intervals and must be applied.

6.3 Test gases

Test gas properties (e.g. relative humidity, concentration) can be found in the relevant sensor data sheet.

The relative humidity of the test gas is not relevant for O₂ sensors.

Different test gases are used depending on the type of calibration.

6.4 Performing the bump test

The bump test can be performed as follows:

- Manual bump test
- Bump test with the bump test station
- Bump test with X-dock

 The Dräger CC-Vision PC software can be used to configure whether a quick or advanced bump test should be performed with the menu or in the bump test station. Dräger recommends using the extended bump test for cross calibrations (see the Dräger X-dock instructions for use).

For the CatEx sensor, we recommend methane as the test gas, including for cross calibration, if methane is expected in the target application.

 X-am 5800: With a manual bump test, consideration must be given to the influence of the H₂ added signal.

An active H₂ added signal will be automatically temporarily deactivated for the duration of a manual calibration, a PC calibration or an automatic bump test.

 The bump test can also be carried out in the password-protected menu.

Prerequisites

- A bump test can only be carried out if at least one sensor has been configured for the bump test with the Dräger CC-Vision PC software (does not apply to bump test with X-dock).
- The gas detector is switched on and warm-up phase 1 is complete.
- A suitable test gas cylinder is available, e.g. test gas cylinder (order number 68 11 130) with the following mixed gas ratios: 50 ppm CO, 15 ppm H₂S, 2.5 Vol% CH₄, 18 Vol% O₂ (other test gas cylinders can be added on request)

WARNING

Health hazard from test gas

Breathing in of test gas can be harmful to health or lead to death.

- ▶ Do not inhale the test gas.
 - ▶ Observe risks connected with the test gas, hazards notes and safety advice (see for example safety data sheets, instructions on the testing media).
-

 Dräger recommends a test gas concentration of <60 %LEL for CatEx sensors and a measuring range of 0 % to 100 %LEL.

1. Connect the test gas cylinder to the calibration adapter (order no. 8318752).
2. Insert the switched-on gas detector into the calibration adapter and press it down until it locks into place.
3. Call the bump test via the Quick menu. Failure to do so means that the bump test is performed without documentation.
4. Open the test gas cylinder valve, the volume flow must be 0.5 L/min and the gas concentration must be higher (lower with O₂) than the alarm threshold concentration that is to be tested.

5. Wait until the detector displays the test gas concentration with sufficient tolerance. (The evaluation is carried out during the advanced bump test by the gas detector.)
 - ⇒ Ex: ± 20 % of the test gas concentration
 - ⇒ IR Ex: ± 20 % of the test gas concentration (X-am 5800 only)
 - ⇒ IR CO₂: ± 20 % of the test gas concentration (X-am 5800 only)
 - ⇒ O₂: ± 0.6 Vol%
 - ⇒ TOX: ± 20 % of the test gas concentration
6. Close the test gas cylinder valve and remove the gas detector from the calibration adapter.
7. If the concentrations have fallen below the A1 alarm thresholds, the gas detector automatically switches back to measuring mode after 30 s at the latest.

Further steps

If the displays are outside of the above-mentioned ranges, have the gas detector calibrated by service personnel.

6.5 Perform a bump test with the Bump Test Station

 The Dräger CC-Vision PC software can be used to configure whether a quick or advanced bump test should be performed. Dräger recommends using the extended bump test for cross calibrations (see the Dräger X-dock instructions for use).

 X-am 2800 bump test with CC-Vision and Bump Test Station: Alarm triggered approx. 3 s after A1 threshold exceeded, if error already present.

 The bump test only starts from measuring mode. Not from a menu or similar.

Prerequisites

- The gas detector is activated for the automatic bump test with the Dräger CC-Vision PC software.
- Measuring channels that are to be used for the automatic bump test have been configured. All measuring channels are used here as standard.
- A suitable test gas cylinder is available, e.g. test gas cylinder (order number 68 11 130) with the following mixed gas ratios: 50 ppm CO, 15 ppm H₂S, 2.5 Vol% CH₄, 18 Vol% O₂ (other test gas cylinders can be added on request)

WARNING

Health hazard from test gas

Breathing in of test gas can be harmful to health or lead to death.

- ▶ Do not inhale the test gas.
- ▶ Observe risks connected with the test gas, hazards notes and safety advice (see for example safety data sheets, instructions on the testing media).

 Dräger recommends a test gas concentration of <60 %LEL for CatEx sensors and a measuring range of 0 % to 100 %LEL.

1. Prepare the Bump Test Station in accordance with the instructions provided in the quick reference guide on the Bump Test Station.
2. Insert the switched-on gas detector into the Bump Test Station and press it down until it locks into place.
3. The bump test starts automatically.  is shown.
4. If a gas alarm (quick bump test) is triggered or the bump test concentration entered (advanced bump test) is reached within the given time, **OK** is shown for the corresponding gas channel.
5. Remove the gas detector from the Bump Test Station.
6. If the concentrations have fallen below the A1 alarm thresholds, the gas detector automatically switches back to measuring mode after 30 s.

Further steps

If the current measured values do not reach the target concentration (“Advanced bump test” only) set during the bump test, an error is triggered.

In this case, repeat the bump test or calibrate the gas detector.

6.6 Check response time (t90)

 The test can also take place in calibration mode in which case the values are not displaced by alarms. If necessary, the values can subsequently be discarded, if the gas detector already has a valid calibration.

1. Carry out a bump test and conduct a simplified check of the response time.
 - a. Connect the test gas cylinder to the calibration adapter and open the valve on the test gas cylinder so that the calibration adapter is purged with test gas.
 - b. Insert the switched-on gas detector into the calibration adapter and press it down until it locks into place. Record the starting time.
 - c. Determine the time until 90 % of the test gas concentration is reached.
2. Compare the measured response time with the previous bump tests and with the t90 values indicated in the supplementary documentation (part number 9033890) provided.

 The determined t90 setting time may differ from the certified setting time, as this simplified procedure does not conform to the standard.

The X-dock maintenance station provides the option of automatically checking the response time.

6.7 Calibrating the gas detector

6.7.1 Notes on calibration

WARNING

Incorrect measured values

Incorrect calibration means that alarms may not be triggered or only with a delay.

- ▶ Always carry out the clean air/zero calibration prior to the span calibration.

 If the calibration gas is changed, the affected channel must be calibrated.

i X-am 5800: An active H₂ added signal will be automatically deactivated temporarily for the duration of a manual calibration, a PC calibration or an automatic bump test.

6.7.2 Performing a fresh air calibration

Observe the following instructions for fresh air calibration:

- To improve accuracy, a fresh air calibration must be carried out if a zero deviation exists.
- For the fresh air calibration, the display on the DrägerSensor XXS O₂ and XXS O₂ PR is set to 20.9 Vol%.

i The fresh air calibration is not supported by the CO₂ channel of the infrared sensor and XXS O₃. A zero calibration of these sensors can be undertaken by performing a single-gas calibration with N₂ or using the Dräger CC-Vision PC software. A suitable zero gas is required here, one that is free from carbon dioxide and ozone (e.g. N₂).



Prerequisites

- The fresh air calibration can only be carried out if at least one sensor supports fresh air calibration.
- The fresh air must be free of measured or interfering gases.
- The gas detector is switched on and warm-up phases 1 and 2 are complete.





To carry out a fresh air calibration:

1. Switch on the gas detector.
2. Call up fresh air calibration (depending on configuration):

Via the Quick menu:

- Press  3x in measuring mode.
- Select and confirm fresh air calibration .

Via the menu:

- a. Press  for approx. 4 s in measuring mode.
 - b. Enter and confirm the password.
 - c. Select and confirm fresh air calibration .
- ⇒ All measurement channels involved in the fresh air calibration flash.
3. Press  to start fresh air calibration manually.
⇒ All measurement channels involved in the fresh air calibration flash.
 4. If necessary, press  to override the stability check. In this case, a calibration takes place immediately.

i Dräger recommends using the automatic stability control (wait until the gas detector has independently carried out the calibration).

⇒ The new measured value is displayed for control purposes.

The result is displayed as follows:

OK fresh air calibration successful.

X fresh air calibration failed.

5. The fresh air calibration is complete when all participating measurement channels have passed or failed the fresh air calibration.
 - Select ✓ to confirm the result.
 - Select ✗ and then confirm the dialogue to discard the result.
 - Select ⬅ to return to the results.

6.7.3 Carrying out a single-gas calibration

Observe the following instructions for single-gas calibration:

- With a zero-point calibration, the zero-point of the selected sensor is set to zero.
- In the case of the span calibration, the sensitivity of the selected sensor is set to the concentration value of the test gas used.
- In order to perform span calibration on the Dräger IR sensors, a valid zero calibration must be available (no more than 30 minutes old) otherwise an acknowledgeable warning is output.
- Use a standard test gas.

Permitted test gas concentration:

Ex-channel of infrared sensor (X-am 5800 only)	20 to 100 % LEL ^{1) 2)} 5 to 100 Vol% ^{1) 2)}
CO ₂ channel of infrared sensor (X-am 5800 only)	0.05 to 5 Vol% ²⁾
CatEx O ₂	The permitted test gas concentration is displayed by the gas detector during single-gas calibration of the sensitivity.
PID HC neo	100 ppm iBut

The permitted test gas concentration of other gases can be read out of the gas detector by the Dräger CC Vision PC software. The permitted concentrations depend on the set parameters (e.g. alarm thresholds).

1) Dependent on measured gas selected.

2) Dependent on measuring range and measurement accuracy.

 Dräger recommends selecting a test concentration in the middle of the respective measuring range or close to the expected measured value.











WARNING

Health hazard from test gas

Breathing in of test gas can be harmful to health or lead to death.

- ▶ Do not inhale the test gas.
- ▶ Observe risks connected with the test gas, hazards notes and safety advice (see for example safety data sheets, instructions on the testing media).

1. Connect the test gas cylinder to the calibration adapter (order no. 8318752).
2. Connect the hose to the second connector on the calibration adapter to direct the test gas to an exhaust or outside.
3. Insert the switched-on gas detector into the calibration adapter and press it down until it locks into place.
4. Press  for approx. 4 s in measuring mode.

5. Enter and confirm the password.
6. Select and confirm single-gas calibration .
The first measuring channel is displayed and the measured gas flashes.
7. Use  to select the desired measuring channel.
8. Press  to start the single-gas calibration for the selected measuring channel.
⇒ The test gas concentration is displayed and flashes.
9. Press  to confirm the test gas concentration, or use  to change the test gas concentration and confirm with . The measured value flashes.
10. Open the test gas cylinder valve, the volume flow must be 0.5 L/min.
11. Wait until the displayed measured value is stable then confirm with .
⇒ The display containing the current gas concentration changes with the display **OK**.
12. Press .
 - Select  to confirm the measured value. The next measuring channel is displayed for calibration, if necessary. After the last measuring channel has been calibrated, the gas detector changes to measuring mode.
 - Select  to discard the measured value and to return to the measuring channel selection.
 - Select  to return to the measured value.
13. After successful single-gas calibration, close the test gas cylinder valve and remove the gas detector from the calibration adapter.

Further steps

If an error occurred during single-gas calibration, the fault message **X** is displayed and -- is displayed for the affected measuring channel instead of the measured value. In this case, repeat the single-gas calibration or replace the sensor, if necessary.

6.7.4

Carrying out a mixed gas calibration

Observe the following instructions for mixed gas calibration:

- All sensors that can be calibrated and have been approved by the Dräger CC-Vision PC software for mixed gas calibration are used in the mixed gas calibration.
- In the case of the span calibration, the sensitivity of the selected sensor is set to the concentration value of the test gas used.

Permitted test gas concentration:

CatEx
O₂

The permitted test gas concentration is displayed by the gas detector during single-gas calibration of the sensitivity.



Test gas concentration of other gasses:
Refer to the Dräger CC-Vision PC software

 Dräger recommends selecting a test concentration in the middle of the respective measuring range or close to the expected measured value.







⚠ WARNING**Health hazard from test gas**

Breathing in of test gas can be harmful to health or lead to death.

- ▶ Do not inhale the test gas.
- ▶ Observe risks connected with the test gas, hazards notes and safety advice (see for example safety data sheets, instructions on the testing media).

1. Connect the test gas cylinder to the calibration adapter (order no. 8318752).
2. Connect the hose to the second connector on the calibration adapter to direct the test gas to an exhaust or outside.
3. Insert the switched-on gas detector into the calibration adapter and press it down until it locks into place.
4. Press  for approx. 4 s in measuring mode.
5. Enter and confirm the password.
6. Select and confirm mixed gas calibration . All measuring channels are shown and flash.

 The channels must be activated for the mixed gas calibration using the Dräger CC-Vision PC software.

7. Press  to start the mixed gas calibration.
8. Open the test gas cylinder valve, the volume flow must be 0.5 L/min.
9. Wait until the measured values displayed are stable and then confirm with .
 - ⇒ The display containing the current gas concentration changes with the display **OK**.
10. Press .
 - Select  to confirm the measured values and switch to the measuring mode.
 - Select  to discard the measured value and return to the mixed gas calibration.
 - Select  to return to the measured value.
11. After successful mixed gas calibration, close the test gas cylinder valve and remove the gas detector from the calibration adapter.

Further steps

If an error occurred during mixed gas calibration, the fault message **X** is displayed and -- is displayed for the affected measuring channel instead of the measured value. In this case, repeat the mixed gas calibration or replace the sensor, if necessary.

6.8 Charging the battery

To protect the battery, charge only in the temperature range of 5 to 35 °C. Outside this temperature range, the charging process is automatically interrupted and automatically continued after the temperature range has been reached again. The charging time is typically 4 h. A new NiMH power pack reaches its full capacity after 3 complete charge/discharge cycles. Never store the gas detector for extended periods without being connected to a power source (maximum of 6 months) because the internal buffer battery will drain.

 The buffer battery can be replaced if necessary.

WARNING

Risk of explosion

To reduce the risk of ignition of a flammable or potentially explosive atmosphere, observe the following:

- ▶ Do not charge or replace the battery in potentially explosive atmospheres or in explosion-hazard areas.
 - ▶ Only use the battery charger specified by Dräger. The use of a different charger nullifies the explosion protection certification of the gas detector.
-
- Insert the gas detector into the charger module.
If the gas detector is switched on, then it is automatically switched off after being inserted.

6.9 Charge the battery with the multicharger

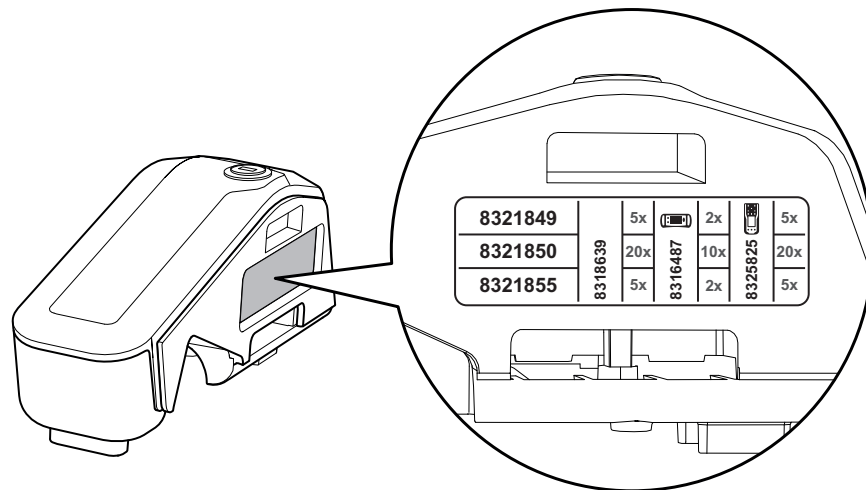

The following power supply units are available:

- 8321849 for max. 5 charging modules
- 8321850 for max. 20 charging modules
- 8321855 for max. 1 charging module when used with X-am 2x00/5x00 (vehicle power supply unit)

NOTICE

Damage to charging modules

If several charging modules are disconnected at the same time, care must be taken as otherwise the projecting tongue may break.

- ▶ Always connect or disconnect the charging modules individually and not in groups.

1. Position the instrument on an even and level surface.
2. When attaching the charging modules, disconnect the power pack from the mains supply.
3. Turn the slit of the lock to the horizontal position with a screwdriver or coin.
4. Insert the projecting tongue of the charging module (simultaneous power supply) until it engages.

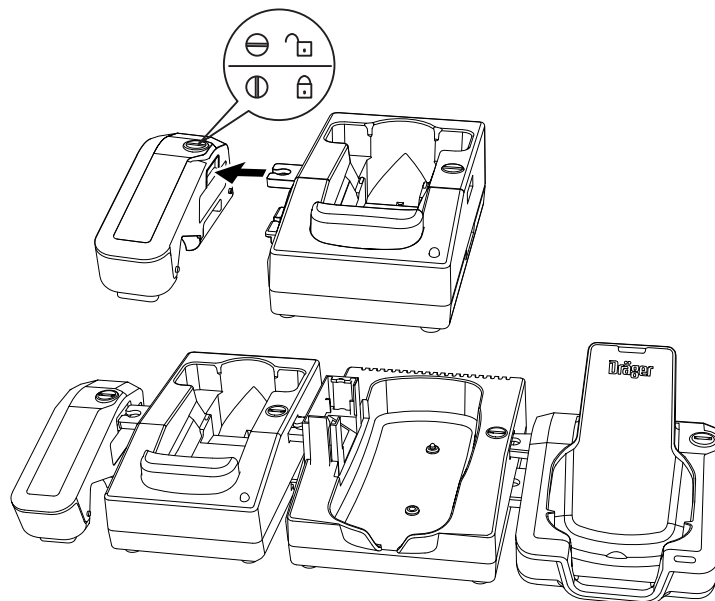

51934

5. Close the lock by turning it by 90 degrees (with the slit vertical).
6. Attach additional charging modules in the same way.
7. Connect the power supply unit to a mains outlet.
 - ⇒ If the red “Overload” LED lights up and an audible alarm sounds, this means there has been a short circuit or the power supply unit is overloaded.
8. Place the gas detector in the corresponding charging cradle.

i An empty rechargeable battery will be fully charged after approx. 4 hours.

- If a fault has been detected: Remove the gas detector from the charging module and then reinsert it. If the fault has not been rectified, contact Dräger service.

i After the fault has been corrected, the alarm is switched off automatically and the charging process is restarted.
In the event of a power failure, the gas detectors already charged will be protected from discharging.

6.10 Replacing the battery

⚠ WARNING

Risk of explosion

To reduce the risk of ignition of a flammable or potentially explosive atmosphere, observe the following:

- ▶ Do not open the gas detector in explosion-hazard areas.
- ▶ Only the battery types specified in the technical data must be used.
- ▶ Do not charge or replace the battery in potentially explosive atmospheres or in explosion-hazard areas.
- ▶ Check that the fastening screw of the battery pack is secure before use.

NOTICE

Damage to the gas detector

The power pack for the X-am 2500/5000/5100/5600 gas detectors (order no. 8318704) must not be used for the X-am 2800, as the seal cannot ensure the IP protection for the X-am 2800 and was not approved together with the X-am 2800.

- ▶ Only use the battery pack (order no. 3703887) with visible part number 3703880 as power pack.

1. Switch off the gas detector.
2. Undo the screw on the power pack.
3. Remove and replace the NiMH power pack T4 (type HBT 0010).
4. Insert the power pack into the gas detector and tighten the screw, the gas detector switches on automatically.

6.11 Exchanging, adding or removing a sensor

i In gas detector X-am 2800, only the permitted sensors may be registered.

i X-am 5800: These gas detectors are delivered with the sensor damper and sensor placeholder installed for CatEx and IR. If a PID sensor is to be installed, the PID X-am 5800 sensor damper set (order no. 3703864) or alternatively the PID neo upgrade set (includes damper and PID HC neo sensor, order no. 3703907) must be purchased.

When a sensor is removed from the gas detector and not replaced, the corresponding sensor placeholder (CatEx/IR or PID or EC (electrochemical sensor)) must be inserted in its place.

Equipment:

- Torx T6 screwdriver for the housing
- Torx T8 screwdriver or Allen key (2 mm) for the power pack
- Special tool for removing EC sensors (Order no. R21402)
- New sensor
- Sensor damper, if required
- Sensor placeholder, if required

Designation and description	Order no.
Sensor damper set: 1x CatEx SR, XD-IR sensor damper	3703865
Sensor damper set: 1x PID HC neo sensor damper	3703864

Exchange the sensors using the Dräger CC-Vision PC program (refer to the Dräger CC-Vision online help). This tests the sensor compatibility and the respective gasses.

Procedure:

1. Connect the gas detector to a PC. For further information, see the following chapter: "Configuring the gas detector with the PC and reading the data memory", page 44.
2. Start the sensor exchange wizard in the Dräger CC-Vision PC software and follow the instructions.
3. Deactivate the corresponding sensor slot.
4. Open the gas detector.
 - a. Loosen the screw and remove the power pack.

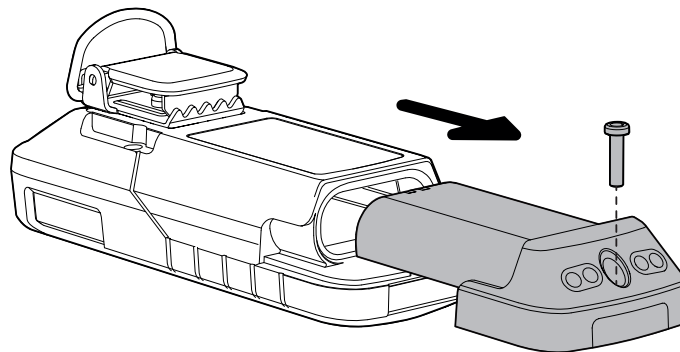

51586

NOTICE

Damage to the display

When lifting out the front housing cradle, it can happen (in rare cases) that the display remains caught in the front housing cradle and becomes damaged as a result.

- Lift out the front housing cradle carefully. If the display gets caught, first carefully loosen the display from the front cradle and then remove the front housing cradle entirely.

- b. Loosen 4 screws and carefully remove the front housing cradle.

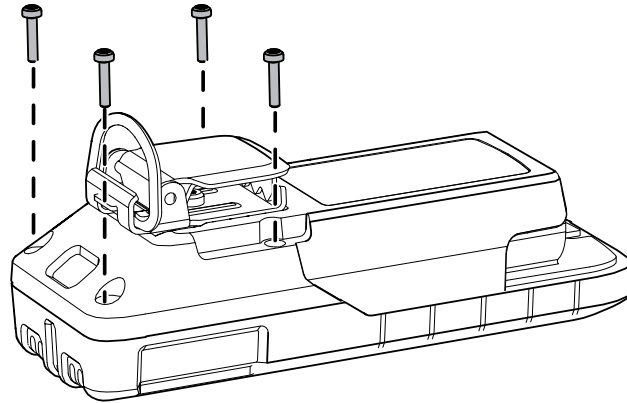

515688

5. Exchanging the EC sensors:

- a. Place the special tool on the trough. Using the special tool, carefully lift out the EC sensor in question. Do not bend the sensor pins.

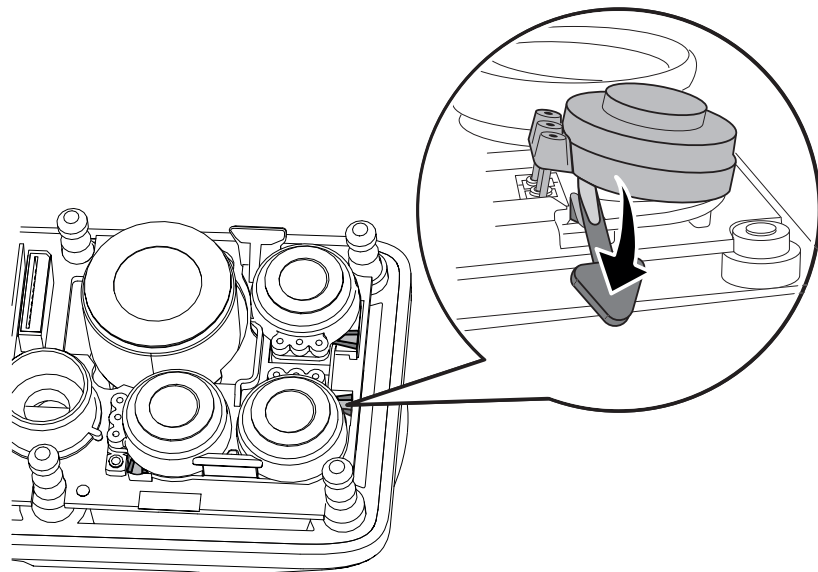

515900

- b. Only if necessary: Exchange the white sensor holder.
- c. Have the sensor type and code (marked on the new sensor), as well as the sensor position, at hand for the following sensor registration on the gas detector.
- d. Carefully insert the new sensor evenly and not at an angle. Make sure that the pins are inserted in the correct positions.
- e. Continue with step 8.
6. Replace the CatEx and PID sensor:

NOTICE

Damage to the flexstrip

If the flexstrip is excessively bent or twisted, it may become irreparably damaged.

► Do not allow the flexstrip to become excessively bent or twisted.

a. Open the sensor damper.

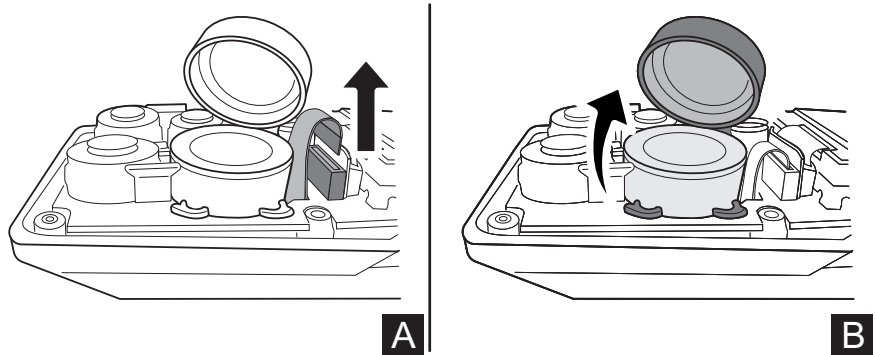

- b. Carefully remove the flexstrip from the printed circuit board and pull out the sensor using a dull instrument (manually using the removal aid (IR) or with a dull instrument, e.g. rounded side of a pair of tweezers (CatEx)).
- c. Have the sensor type and code (marked on the new sensor) as well as the sensor position at hand for the new sensor inauguration.
- d. Carefully insert the new sensor first.
- e. Carefully plug the flexstrip into the bushing on the options board.
- f. Close the sensor damper and make sure that it is positioned correctly.
- g. Continue with step 8.

7. Replace the IR sensor:

NOTICE

Damage to the flexstrip

If the flexstrip is excessively bent or twisted, it may become irreparably damaged.

► Do not allow the flexstrip to become excessively bent or twisted.

a. Open the sensor damper.

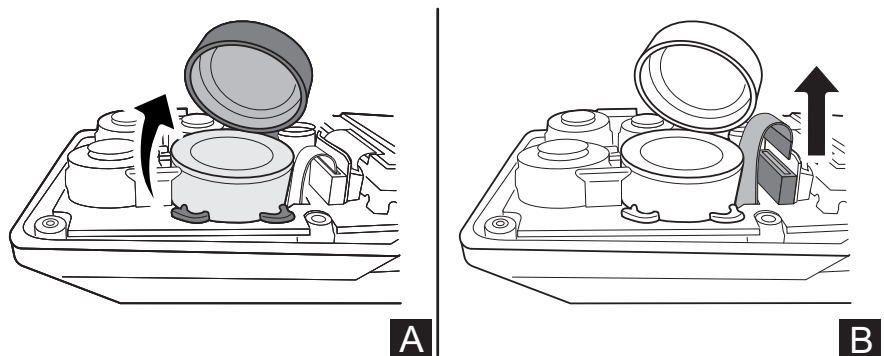

- b. Carefully pull out the sensor and only then detach the flexstrip from the printed circuit board.

- c. Have the sensor type and code (marked on the new sensor) as well as the sensor position at hand for the new sensor inauguration.
 - d. Carefully insert the new sensor.
 - e. Carefully plug the flexstrip into the bushing on the options board.
 - f. Close the sensor damper and make sure that it is positioned correctly.
8. Reattach the front and rear housing cradles and make sure that the seals and sensor dampers are in the correct positions.
 9. Screw on the rear housing cradle with 4 screws (35 ± 5 Ncm).

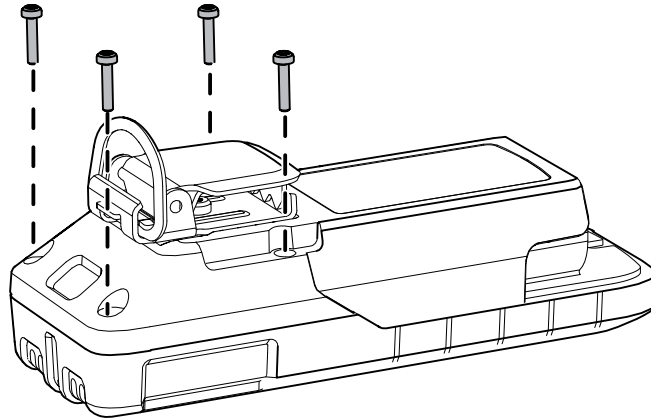

511888

 Dräger recommends first tightening the two lower housing screws and then the two upper ones.

10. Follow the instructions in the sensor exchange wizard in the CC-Vision PC software.

Next steps:

- After every sensor exchange, the fresh air calibration/ zero calibration must first be carried out followed by the span calibration (mixed-gas or single-gas calibration).
- For the XXS O₂, Dräger recommends testing the alarm feature with a suitable test gas after the fresh air calibration.

6.12 Cleaning the PID lamp (X-am 5800 only)

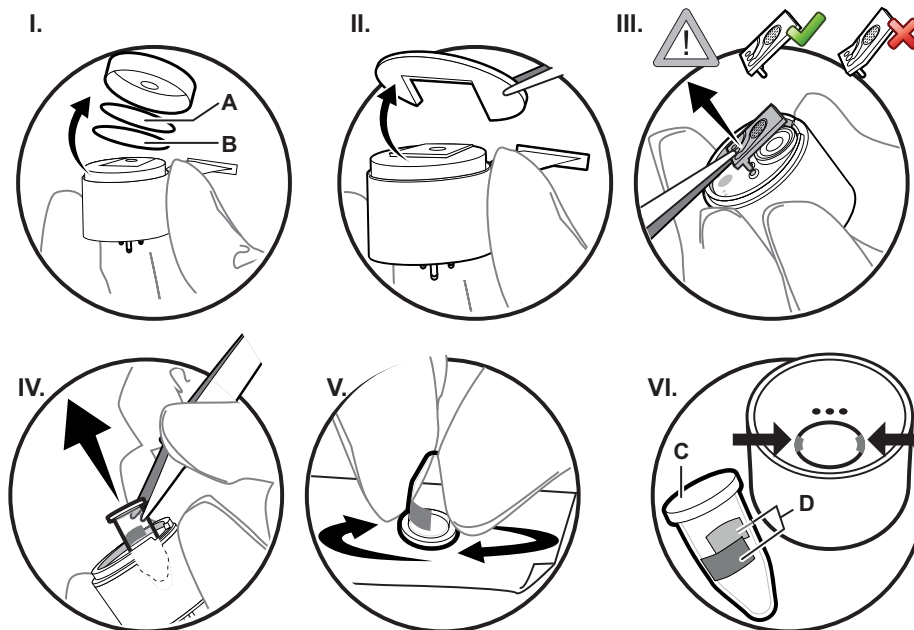

During calibration of the PID, the gas detector identifies when there is dirt on the lamp and displays a corresponding warning. If this warning is displayed, the lamp window must be cleaned. Silicone-free disposable nitrile gloves and the DrägerSensor PID cleaning set (order no. 83 19 111) must be used for this. The cleaning set is for single use.

⚠ WARNING

Imprecise measured value (for PID)!

Contamination of the front lamp window (C) may negatively influence the measured value.

- ▶ Do not scratch or soil the front lamp window.

To clean the PID lamp:

1. Remove the sensor.
2. Remove the sensor cap and the two filters (I).
3. Remove the plastic insert, e.g. by using tweezers to lift it out at the edge of the sensor (II).
4. Lift out the ionisation cell by carefully inserting the tweezers on the side with the contact pins (III). Do not allow the ionisation cell to become bent during this process.
5. Use tweezers to remove the UV lamp. Insert the tweezers and carefully tilt them at the edge of the housing to lift the UV lamp out of the opening (IV).
6. Hold the UV lamp on the cylindrical body and position the lamp window (C) flat on the surface of the sandpaper. Polish the lamp window by using circular movements (for approx. 5 to 10 seconds) and applying gentle pressure to the surface of the sandpaper (V).

7. Put the UV lamp back in. Make sure that the metal surfaces (D) of the lamp are aligned so that they come into contact with the spring contacts in the sensor housing (VI). Apply gentle pressure to the lamp window to push the UV lamp into the opening, making sure not to scratch it or get dirt on it.
8. To put the ionisation cell back in place, insert the contact pins into the openings of the sensor printed circuit board and carefully push in until the cell lies flat on the lamp window. Do not allow the ionisation cell to become bent.
9. Position the plastic insert.
10. Position a new cotton filter (B; from the PID cleaning set).
11. Position a new water protection film (A; from the PID cleaning set) with the shiny side facing up.
12. Position the sensor cap (with the opening over the ionisation cell). The sensor cap must latch into place.
13. Install the sensor.
14. Carry out zero calibration.
15. Carry out the span calibration.

If the warning persists after cleaning and the sensor cannot be calibrated, the PID must be replaced.

6.13 Exchange the device components

WARNING

Loss of explosion protection!

Incorrect assembly or disassembly may compromise IP or explosion protection.

- ▶ Make sure that all seals are in their correct positions.
- ▶ The seals and sealing surfaces may not be damaged and must be clean.

6.13.1 Opening the gas detector

NOTICE

Loss of data and damage to the gas detector!

If the housing is opened when the gas detector is switched on, this may cause a loss of data and damage to the gas detector.

- ▶ Turn off the gas detector before opening the housing.

NOTICE

Damage to components!

The gas detector includes components that may become charged.

- ▶ Before opening the gas detector to replace the sensor, make sure the person carrying out the work is grounded in order to avoid damage to the gas detector. An ESD workplace (ElectroStatic Discharge), for example, will ensure the grounding takes place.

Equipment:

- Torx T6 screwdriver for the housing
- Torx T8 screwdriver or Allen key (2 mm) for the power pack

Procedure:

1. Switch off the gas detector.
2. Loosen the screw and remove the power pack.

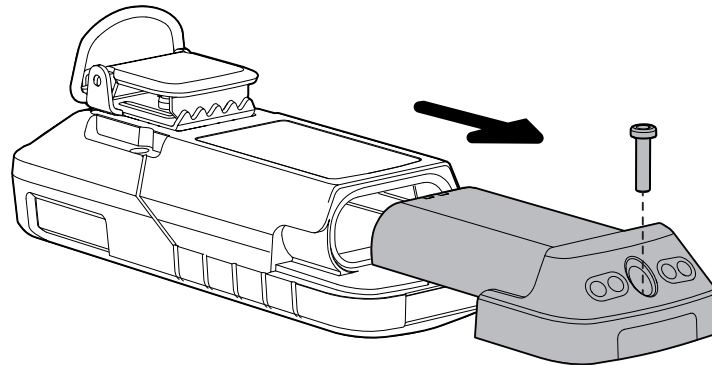

51586

NOTICE

Damage to the display

When lifting out the front housing cradle, it can happen (in rare cases) that the display remains caught in the front housing cradle and becomes damaged as a result.

- ▶ Lift out the front housing cradle carefully. If the display gets caught, first carefully loosen the display from the front cradle and then remove the front housing cradle entirely.

3. Loosen 4 screws and carefully remove the front housing cradle.

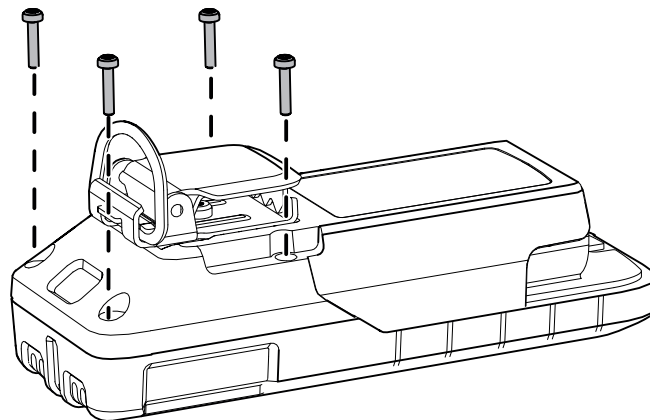

51588

6.13.2 RFID transponder (optional)

The gas detector may also include an RFID transponder. The transponder is mounted to the lower part of the housing using double-sided adhesive tape.

Prerequisites:

- The gas detector is open.

1. Carefully remove the old RFID transponder (1) from the housing.

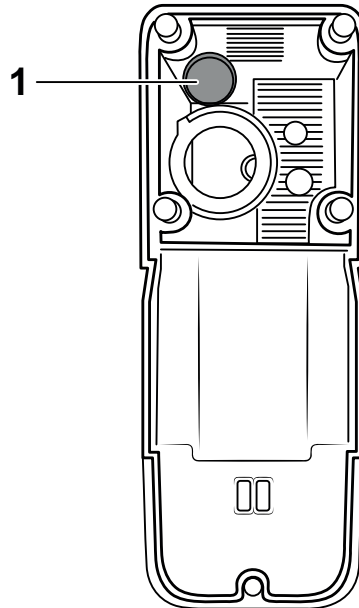

56093

2. Remove the foil from the adhesive tape of the new transponder.
3. Insert the new RFID transponder (1) into the left upper corner of the lower part of the housing and press into place.

 The adhesive tape is very strong and cannot be removed again without becoming damaged once it has been pressed into place.

4. Read out the RFID transponder identifier and save it to the device using the Dräger CC-Vision PC software.

6.13.3 Horn resonator

Prerequisites:

- The gas detector is open.
1. Carefully lift the defective horn resonator from the printed circuit board using a tweezers; the adhesive ring may prove difficult to take off.
 2. Carefully remove the adhesive ring and adhesive residue from the printed circuit board using a blunt plastic object.
 3. The spare part comes equipped with an adhesive ring. Get the adhesive ring ready, affix it to the resonator if required.
 4. Place the resonator with adhesive ring on the printed circuit board, guide the pins of the resonator into the guide holes and press firmly on the resonator.

 Guides at 1 o'clock and 7 o'clock on the resonator help to accurately position the resonator on the PCB.

5. Close the gas detector.

6.14 Cleaning

The gas detector does not require any special care.

If it is heavily soiled, wash off the gas detector with cold water, using a sponge if necessary. Dry the gas detector with a cloth.

NOTICE

Damage to the gas detector!

Harsh cleaning utensils (e.g. brushes), detergents and solvents can destroy the dust and water filters.

► Only clean the gas detector with cold water and, where necessary, a sponge.



For information on suitable cleaning agents and disinfectants and their specifications, see document 9100081 at www.draeger.com/IFU.

7 Configuration

ⓘ After a change to the configuration (e.g. with the CC-Vision PC software), check the basic functions of the gas detector (e.g. alarm elements).

7.1 Standard gas configuration for X-am 2800

Different settings can be selected to meet customer requirements on delivery. The current setting can be checked and changed with the Dräger CC-Vision PC software.

The Dräger CC-Vision PC software can be downloaded at www.draeger.com/software.

DrägerSensor	Measuring range	Alarm A1 - threshold	acknowledgedgeable	latching	Alarm A2 - threshold	acknowledgedgeable	latching
CatEx SR [%LEL]	0 to 100	20	✓	-	40	-	✓
XXS O ₂ [Vol%] ¹⁾	0 to 25	↓19.5 ↑22.5	-	✓	↓19 ↑23	-	✓
XXS O ₂ PR [Vol%] ^{1) 2)}	0 to 30	↓19.5 ↑22.5	-	✓	↓19 ↑23	-	✓
XXS CO LC [ppm]	0 to 2000	30	✓	-	60	-	✓
XXS H ₂ S LC [ppm]	0 to 200	5	✓	-	10	-	✓
XXS NO ₂ [ppm]	0 to 50	5	✓	-	10	-	✓
XXS SO ₂ [ppm]	0 to 100	0.5	✓	-	1	-	✓

1) There are 4 alarm thresholds for O₂ 2 ↑ (increasing) and 2 ↓ (decreasing).

2) Only available to order as an option in the modular variant 3703900.

7.2 Standard gas configuration for X-am 5800

Different settings can be selected to meet customer requirements on delivery. The current setting can be checked and changed with the Dräger CC-Vision PC software.

The Dräger CC-Vision PC software can be downloaded at www.draeger.com/software.

DrägerSensor	Measuring range	Alarm A1 - threshold	acknowledgeable	latching	Alarm A2 - threshold	acknowledgeable	latching
CatEx SR [%LEL]	0 to 100	20	✓	-	40	-	✓
IR Ex/CO ₂ :							
IR Ex [%LEL]	0 to 100	20	✓	-	40	-	✓
IR CO ₂ [Vol%]	0 to 5	0.5	✓	-	1.0	-	✓
IR Ex [%LEL]	0 to 100	20	✓	-	40	-	✓
IR CO ₂ [Vol%]	0 to 5	0.5	✓	-	1.0	-	✓
XXS O ₂ [Vol%] ¹⁾	0 to 25	↓19.5 ↑22.5	-	✓	↓19 ↑23	-	✓
XXS O ₂ PR [Vol%] ¹⁾	0 to 30	↓19.5 ↑22.5	-	✓	↓19 ↑23	-	✓
XXS O ₂ 100 [Vol%]	0 to 100	↓18.5 ↑24	-	✓	↓17.5 ↑25	-	✓
XXS O ₂ /CO-LC [Vol%] / [ppm]	0 to 25 O ₂ 0 to 2000 CO	↓19 ↑23 O ₂ 2 30 CO	- ✓	✓ -	↓17 ↑24 O ₂ 2 60 CO	- -	✓ ✓
XXS O ₂ / H ₂ S-LC [Vol%] / [ppm]	0 to 25 O ₂ 0 to 100 H ₂ S	19 O ₂ 5 H ₂ S	- ✓	✓ -	23 O ₂ 10 H ₂ S	- -	✓ ✓
XXS CO LC [ppm]	0 to 2,000	30	✓	-	60	-	✓
XXS CO HC [ppm]	0 to 10,000	600	✓	-	1200	-	✓
XXS CO H ₂ -CP [ppm]	0 to 2,000	30	✓	-	60	-	✓
XXS H ₂ [ppm]	0 to 2,000	200	✓	-	400	-	✓
XXS H ₂ HC [Vol.-%]	0 to 4	0.8	✓	-	1.6	-	✓
XXS H ₂ S LC [ppm]	0 to 200	5	✓	-	10	-	✓
XXS H ₂ S HC [ppm]	0 to 1,000	10	✓	-	20	-	✓
XXS H ₂ S-LC/CO-LC [ppm]	0 to 100 H ₂ S 0 to 2000 CO	5 H ₂ S 30 CO	✓ ✓	- -	10 H ₂ S 60 CO	- -	✓ ✓
XXS NO [ppm]	0 to 200	25	✓	-	50	-	✓
XXS NO ₂ [ppm]	0 to 50	5	✓	-	10	-	✓

DrägerSensor	Measuring range	Alarm A1 - threshold	acknowledgeable	latching	Alarm A2 - threshold	acknowledgeable	latching
XXS NO ₂ LC [ppm]	0 to 50	0.5	✓	-	1.0	-	✓
XXS SO ₂ [ppm]	0 to 100	0.5	✓	-	1	-	✓
XXS PH ₃ [ppm]	0 to 20	0.1	✓	-	0.2	-	✓
XXS PH ₃ HC [ppm]	0 to 2,000	5	✓	-	10	-	✓
XXS HCN [ppm]	0 to 50	1.9	✓	-	3.8	-	✓
XXS HCN PC [ppm]	0 to 50	5	✓	-	10	-	✓
XXS NH ₃ [ppm]	0 to 300	20	✓	-	40	-	✓
XXS CO ₂	0 to 5	0.5	✓	-	1	-	✓
XXS Cl ₂ [ppm]	0 to 20	0.5	✓	-	1	-	✓
XXS OV [ppm]	0 to 200	10	✓	-	20	-	✓
XXS OV-A [ppm]	0 to 200	10	✓	-	20	-	✓
XXS Odorant [ppm]	0 to 40	10	✓	-	20	-	✓
XXS Amine [ppm]	0 to 100	10	✓	-	20	-	✓
XXS COCl ₂ [ppm]	0 to 10	0.1	✓	-	0.2	-	✓
XXS O ₃ [ppm]	0 to 10	0.1	✓	-	0.2	-	✓
PID HC neo Isobutylene	0.3 ... 2,000	50	✓	-	100	-	✓

1) There are 4 alarm thresholds for O₂ 2 ↑ (increasing) and 2 ↓ (decreasing).

7.3 Configuring the gas detector

i When a configuration is transmitted to the gas detector with the CC-Vision PC software, existing TWA and STEL evaluations are reset.

i Before carrying out a firmware update with the assistance of the PC software CC-Vision, make sure that the battery is least 50 % charged. The most recent PC software CC-Vision contains information concerning whether a firmware update is available.

7.3.1 Configuring the gas detector with the PC and reading the data memory

7.3.1.1 Connect the gas detector to a PC.

Equipment:

- DIRA USB cable (order number 8317409)
- Calibration adapter (order number 8318752)

Procedure:

1. Plug the DIRA dongle mount with the dongle into the socket for the calibration adapter.
2. Insert the switched-on gas detector into the calibration adapter and press it down until it locks into place.
3. Connect the DIRA USB cable to the PC.

7.3.1.2 **Configuring the gas detector with the Dräger CC-Vision PC software and reading the data memory**

Requirements:

- The gas detector is connected to the PC.

To configure the gas detector using the Dräger CC-Vision PC program, refer to the Dräger CC-Vision online help.

With the Dräger CC-Vision PC software, the data logger can be downloaded as a JSON file.

7.3.1.3 **Reading the data memory with Dräger GasVision**

Requirements:

- The gas detector is connected to the PC.

The data memory is read and visually represented with the Dräger GasVision PC software (refer to the Dräger GasVision online help).

An interface is available for the infrared communication when reading out the measured values in external devices. Contact Dräger for more information concerning the use of this interface.

8 **Device settings**

Only trained and qualified personnel may change the device settings.

8.1 **Factory settings**

Different settings can be selected to meet customer requirements when ordering. The setting can be checked and changed with the Dräger CC-Vision PC software.

Device settings via CC-Vision:

i The changed parameter settings must be checked after being transferred to the gas detector to ensure that the values have been transferred correctly. Parameters that cannot be viewed on the gas detector must be read out and checked after being changed using the Dräger CC-Vision PC software.

Device settings via a cloud solution:

i In order to guarantee compliance with EN 50271, the transmitted parameters must be verified when configuration settings are changed.

Feature	Setting
Fresh air calibration without password ¹⁾	On
Bump test without password	On
Hydrogen added signal ²⁾	On
Life signal (acoustic)	Off
Automatic distress signal	Off
Bluetooth®	Off
Switch off is allowed	On
Capture range ³⁾	On
LEL factor ⁴⁾	
CH ₄ (methane) ⁵⁾	4.4 Vol% (corresponds to 100 %LEL)
H ₂ (hydrogen)	4.0 Vol% (corresponds to 100 %LEL)
C ₃ H ₈ (propane)	1.7 Vol% (corresponds to 100 %LEL)
STEL	STEL feature – inactive; average duration = 15 minutes
TWA	TWA feature – inactive; average duration = 8 hours
Configuration type alarm thresholds	ATEX compliant
Alarm A1	Acknowledgeable; non-latching, pre-alarm, increasing measured value (for O ₂ sensor, decreasing measured value as well)
Alarm A2	Not acknowledgeable; latching, main alarm, increasing measured value (for O ₂ sensor, decreasing measured value as well)
Expired bump test interval	Channel warning
Expired calibration interval	Channel warning

- 1) The fresh air calibration/zero calibration is not supported by the CO₂ channel of the infrared sensor and XXS O₃.
- 2) With XXS H₂ HC activated and Ex channel of the DUAL IR Ex/CO₂ or IR Ex activated.
- 3) The capture range can be activated or deactivated with the Dräger CC-Vision PC software. The capture range is activated in measuring mode ex works. The capture range is always deactivated in calibration mode.
- 4) An LEL factor can be adapted to national regulations using the Dräger CC-Vision PC software.
- 5) Notation in the gas detector: ch4

8.2 Device and sensor settings

Name:	Area / setting
Device settings:	
Password(s)	Numerical range (4-digit)
Acoustic life signal	Yes / No
Switch-off mode	“Switch off is allowed” or “Switch off not allowed” or “Switching off not allowed during A2”
Short-term exposure limit (STEL) ¹⁾²⁾	0 - 60 (in minutes; setting for exposure alarm)

Name:	Area / setting
Shift length (TWA) ³⁾	60 - 1440 (in minutes; setting for exposure alarm)
Automatic distress signal	Pre-alarm 1-600 s
Period for triggering	Additional main alarm 1-600 s.
Sensor settings:	
A1 alarm:	
Latching	On / Off
Acknowledgeable	On / Off
A2 alarm:	
Acknowledgeable	On / Off
Alarm threshold A1 increasing (in measurement module)	0 to A2
Alarm threshold A2 increasing ⁴⁾ (in measurement module)	A1 to full scale deflection
Alarm threshold A1 decreasing (in measurement module, only O2 sensor)	A2 decreasing to A1 increasing
Alarm threshold A2 decreasing (in measurement module, only O2 sensor)	0 to A1 decreasing
Evaluation type ¹⁾	Inactive, TWA, STEL, TWA+STEL
Alarm threshold STEL (in measurement module) ¹⁾	0 – full scale deflection
Alarm threshold TWA (in measurement module) ¹⁾	0 – full scale deflection

- 1) Evaluation only if the sensor is designed for this.
2) Corresponds to averaging time and is used to calculate the STEL exposure value.
3) Corresponds to averaging time and is used to calculate the TWA exposure value.
4) Max. 60 %LEL applies for ex-channels

8.3 Alarm settings (factory setting)

Definition:

Pre-acknowledgement: If, during the alarm condition, the acknowledgement is actuated (by pressing the OK button), the audible alarm and the vibration are switched off. The alarm is only fully reset (LED and display) once the alarm condition no longer exists.

























Acknowledgement: If an acknowledgement is actuated when the A1 alarm condition no longer exists (by pressing the OK button), all alarm elements will be reset.

 If the A2 and A1 alarms are configured as acknowledgeable, a pre-acknowledgement or acknowledgement of the A2 alarm will pre-acknowledge the A1 alarm or fully acknowledge it if no further alarm condition exists.

Explanation of symbols:

: Feature activated

: Pre-acknowledgement

Alarms / Events	Representation in display	Latching	Acknowledgeable	LEDs	Horn	Vibration
A1 ↑ (increasing)	A1	-	✓ 			✓
A2 ↑ (increasing)	A2	✓	-			✓
A1 ↓ (decreasing)	A1	-	✓ 			✓
A2 ↓ (decreasing)	A2	✓	-			✓
STEL ¹⁾²⁾	STEL	✓	-			✓
TWA ³⁾	TWA	✓	-			✓
Error⁴⁾						
Battery pre-alarm ⁵⁾	-	-	✓			✓
Battery main alarm ⁶⁾	-	-	-			✓
Device error		✓	✓			✓
Channel error		-	✓			✓

1) The STEL alarm can trigger with a delay of up to one minute.

2) The work being carried out must be regulated in accordance with national regulations after this alarm.

3) A TWA alarm can only be reset by switching the gas detector off and then on again.

4) For troubleshooting, see the Technical Manual.

5) The battery will last another approx. 10 minutes once the battery pre-alarm has been triggered.

6) The gas detector automatically switches off after 20 s when the battery main alarm is triggered.

9 Storage

Dräger recommends storing the device in the charging module (order no. 8318639).

Dräger recommends checking the charge status of the energy supply every 3 weeks at the latest and charging the gas detector when the device is not stored in the charging module.

10 Disposal



This product must not be disposed of as household waste. This is indicated by the adjacent symbol.



You can return this product to Dräger free of charge. For information please contact the national marketing organizations or Dräger.



Batteries must not be disposed of as household waste. They are therefore marked with the adjacent symbol. Dispose of batteries at battery collection centres as specified by the applicable regulations.

11 Technical data

11.1 Gas detector

Ambient conditions:

during operation and storage	-20 to +50 °C (measuring function and storage) -40 to +50 °C (use in areas subject to explosion hazards) ¹⁾ 700 to 1300 hPa (measuring function) 800 to 1100 hPa (use in areas subject to explosion hazards) 10 to 90 % (briefly up to 95 %) r.h.
------------------------------	--

Degree of protection	IP 68 ²⁾
Alarm volume	>90 dB (A) at a distance of 30 cm
Orientation	Any

Storage time of gas detector	1 year
Storage time of sensors	The ambient conditions and storage time for sensors in original packaging correspond to that of the gas detector

Power packs for temperature class T4
(-40 to +50 °C, use in areas subject to explosion hazards):
NiMH power packs type: HBT 0010

Electrical parameters for the charging pins ³⁾ :	U _m = 4.6 V I _m = 1.36 A
---	---

Dimensions	approx. 130 x 48 x 44 mm (H x W x D)
Weight	Typically 220 to 250 g, depending on the sensor configuration
Update interval for the display and signals	1 s
Range of Bluetooth [®]	approx. 95 m (line of sight)

- 1) The minimum permissible ambient temperature is reduced to -20 °C when the gas detector is equipped with a PID sensor.
- 2) Tested with power pack HBT 0010 (order no. 3703887)
- 3) The parameters are complied with when using the battery charger specified by Dräger.

Operating time for X-am 2800 under normal conditions (diffusion mode)¹⁾:

with CatEx and 3 EC sensors	Typically 12 h
with 3 EC sensors	Typically 100 h

- 1) Nominal operating time of the gas detector at an ambient temperature of 20 to 25 °C, 1013 hPa, less than 1 % alarm time. The actual operating time will vary depending on the ambient temperature and pressure as well as the rechargeable battery and alarm conditions.

Operating time for X-am 5800 under normal conditions (diffusion mode)¹⁾:

with CatEx and 3 EC sensors	Typically 12 h
with XD IR and 3 EC sensors	Typically 100 h
with PID and 3 EC sensors	typically 24 h
with 3 EC sensors	Typically 100 h

- 1) Nominal operating time of the gas detector at an ambient temperature of 20 to 25 °C, 1013 hPa, less than 1 % alarm time. The actual operating time will vary depending on the ambient temperature and pressure as well as the rechargeable battery and alarm conditions.

11.2 Dimensions

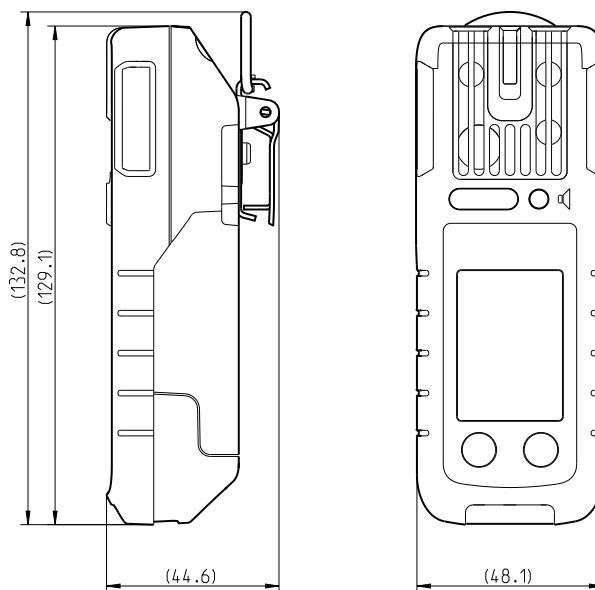

51739

11.3 Dimensions for vehicle mount

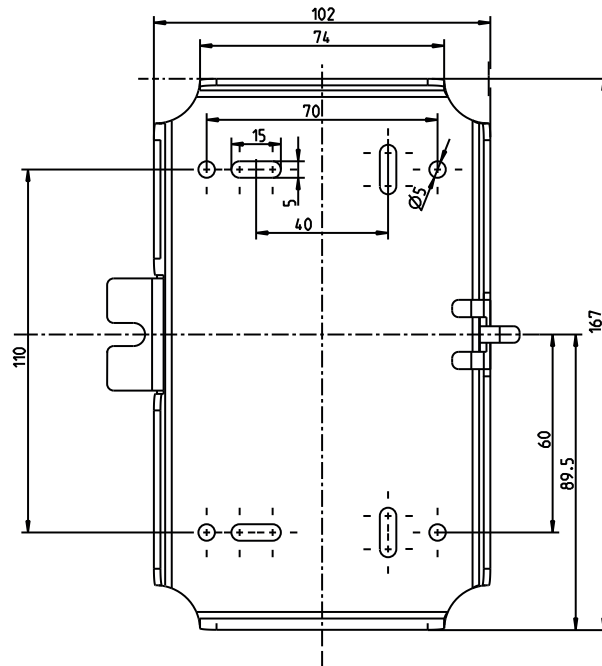

56128

 Manufacturer
Dräger Safety AG & Co. KGaA
Revalstraße 1
D-23560 Lübeck
Germany
+49 451 8 82-0

9300310 – 4638.280 en
© **Dräger Safety AG & Co. KGaA**
Edition: 6 – 2024-03 (Edition: 1 – 2021-10)
Subject to alterations

www.draeger.com

